

La collection d'accessoires Rest se compose d'un dossier en bois universel pour bancs en béton et d'un accoudoir en métal. Les deux sont compatibles avec une large gamme de bancs et de bancs du catalogue d'Escofet, répondant aux exigences d'accessibilité et de confort, que ce soit en les combinant ou individuellement. Il répond aux exigences d'ergonomie et de convivialité pour faciliter l'assise des personnes à mobilité réduite qui ont besoin de ce support. Il est fait d'acier galvanisé et peint en argent texturé. Alternativement en acier inoxydable.

Acier | Bois Certifié FSC® |  400 mm |  3,25 kg

 Update 11.11.2024

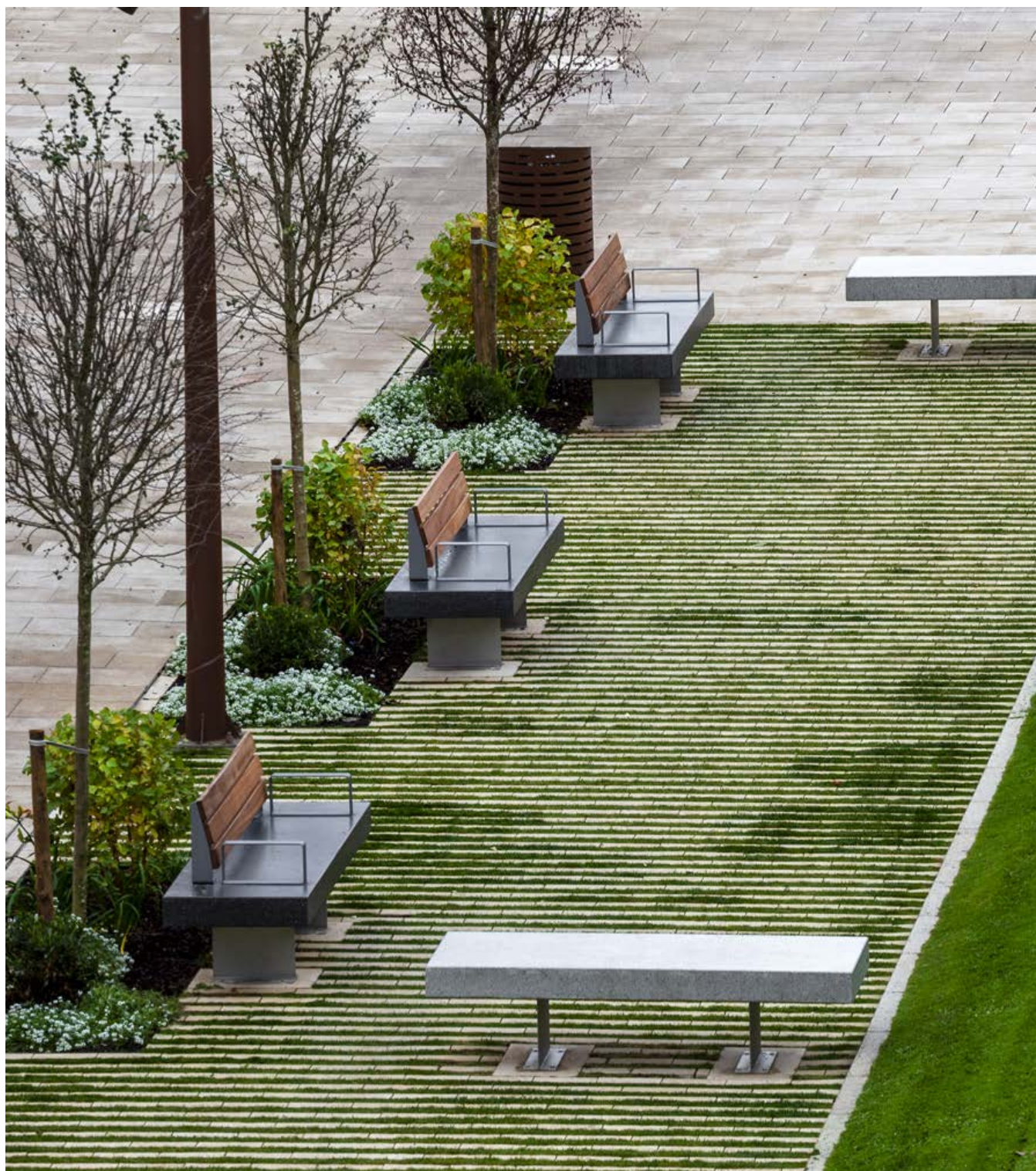

REST

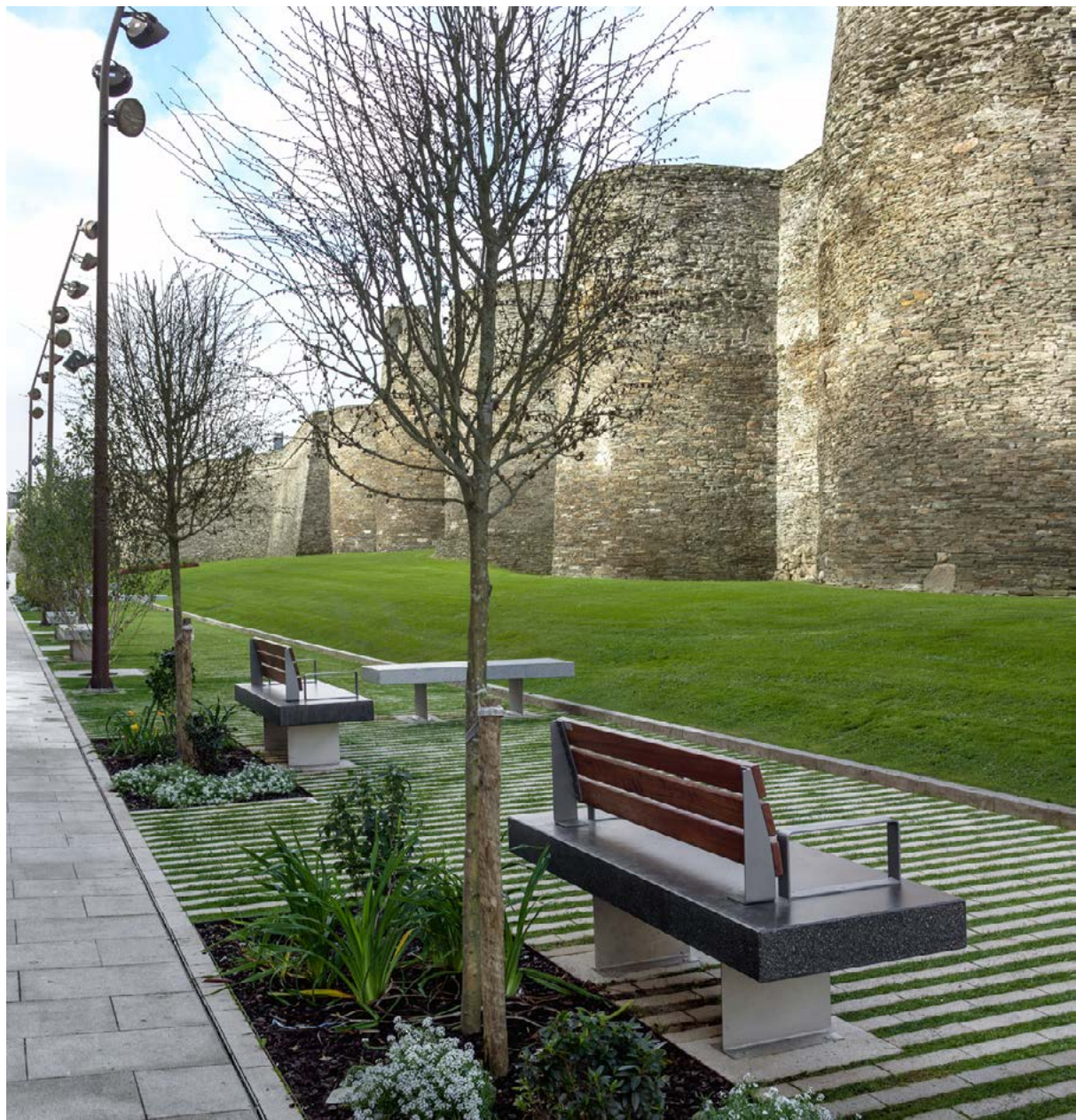

Escofet®

1. Accoudoir générique

Rest Accoudoir

Dimensions 400 x 60 x 200 mm e=6 mm

Poids 3,25 kg

1.1 Caractéristiques générales

Matériel Acier zingué
Acier inoxydable

Pose Ancré sur le banc

Finition Peinture couleur argent texturé ou RAL avec protection contre la corrosion pour une catégorie de corrosivité atmosphérique C5 selon la norme UNE-EN ISO 12944-2. / Grenailage

Couleurs

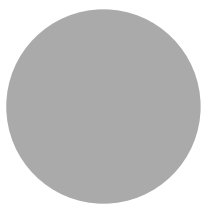

A. Acier argent texturé

B. Acier inox. AISI 316

1.2 Géométrie

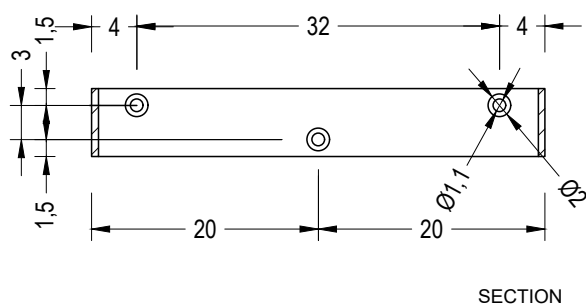
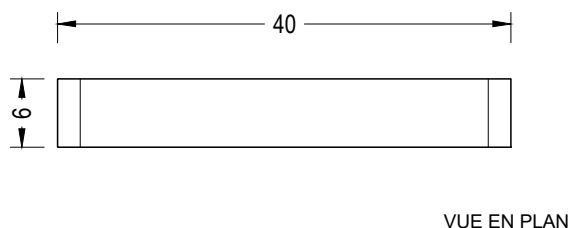
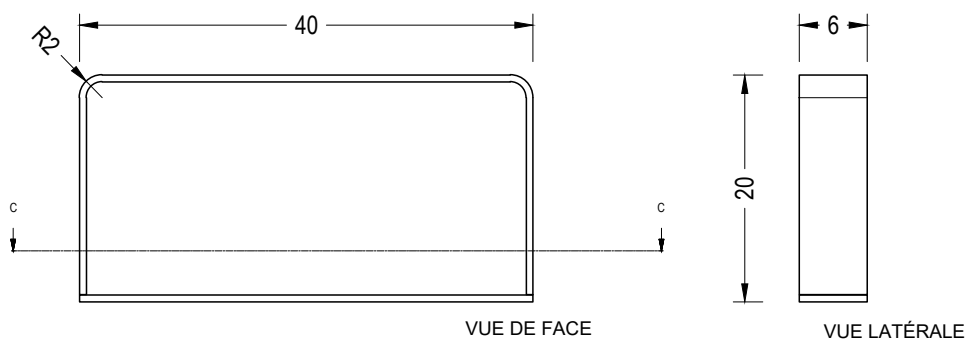

1.3. Système de pose

Rest Accoudoir

1. Centrez et positionnez l'accessoire sur le banc ou le mur et marquez les trous, percez le banc ou le mur et positionnez la fixation.

2. Incorpore les rondelles en nylon pour séparer l'accoudoir du support. Insérez et vissez les 3 bouchons d'expansion de 8 x 45mm.

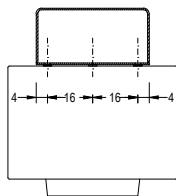
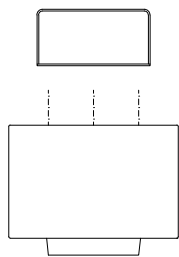

1.4. Compatibilité Rest Accoudoir

SOCRATES + ARMREST

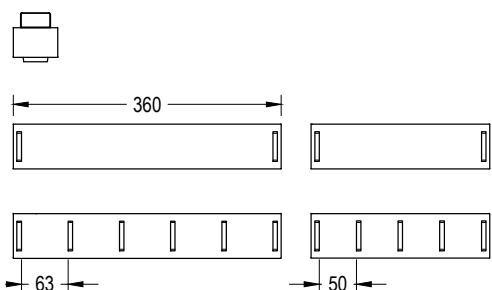

LONGO + ARMREST

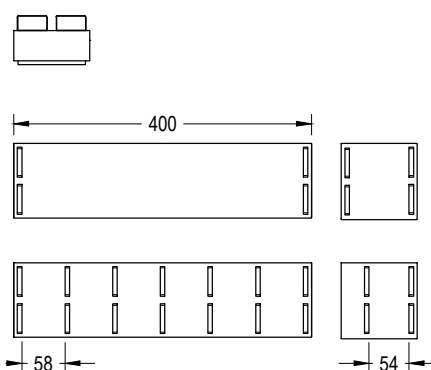

BOX + ARMREST

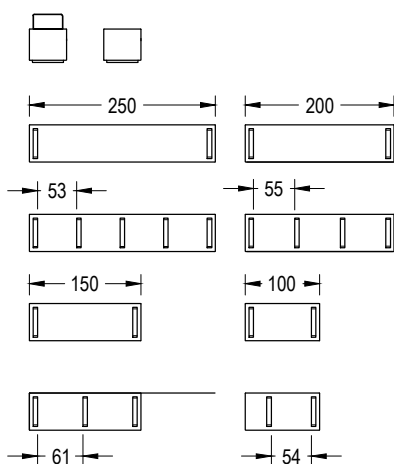

PORTIC + ARMREST

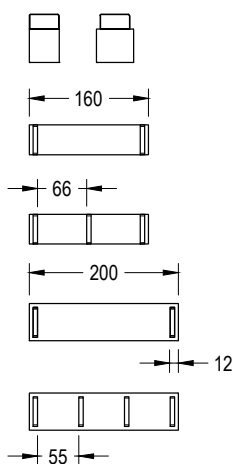

GARONNE + ARMREST

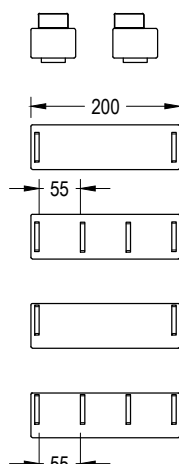

GENEVE + REST

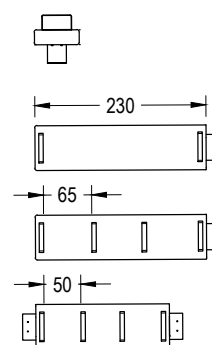

GODOT + ARMREST

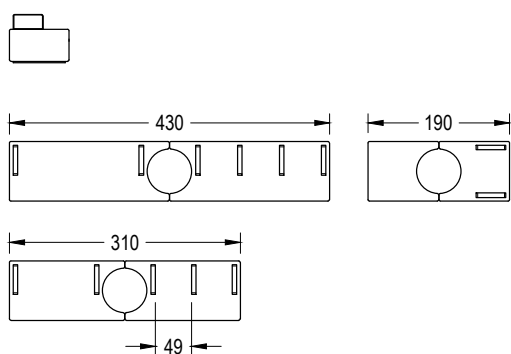

BANCALOSA + ARMREST

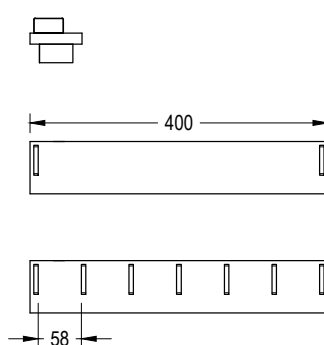

1.4. Compatibilité Rest Accouoir

Rest Accouoir

LONGO + ARMREST

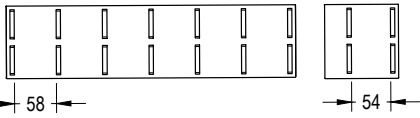
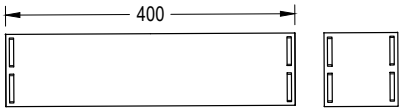

LEVIT + ARMREST

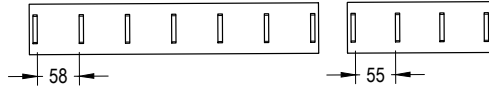
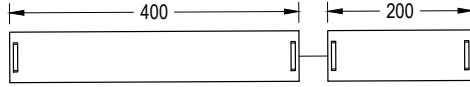
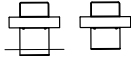

BAND + ARMREST

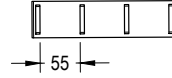
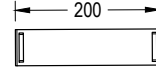

COMU + ARMREST

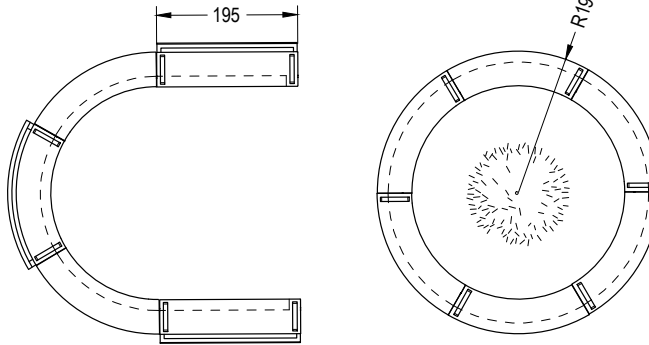
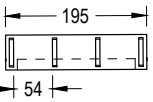
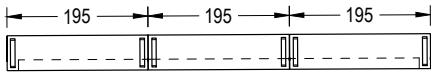

Box



Sócrates

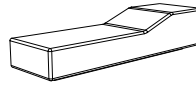

Garonne

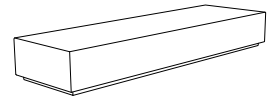

Longo

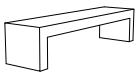

Portic

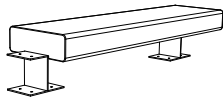

Geneve



Abril

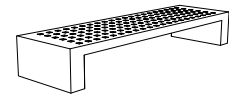

Mayo

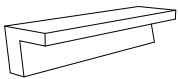

Hydra

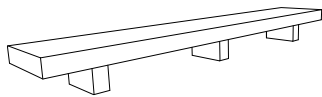

Bancalosa

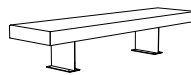

Levit

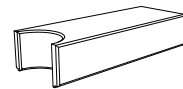

Godot

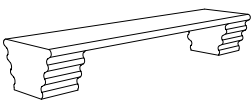

Hebi

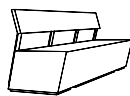

Zuera

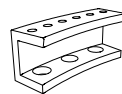

Villette

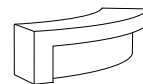

Comú



Band

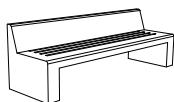

Junio



REST

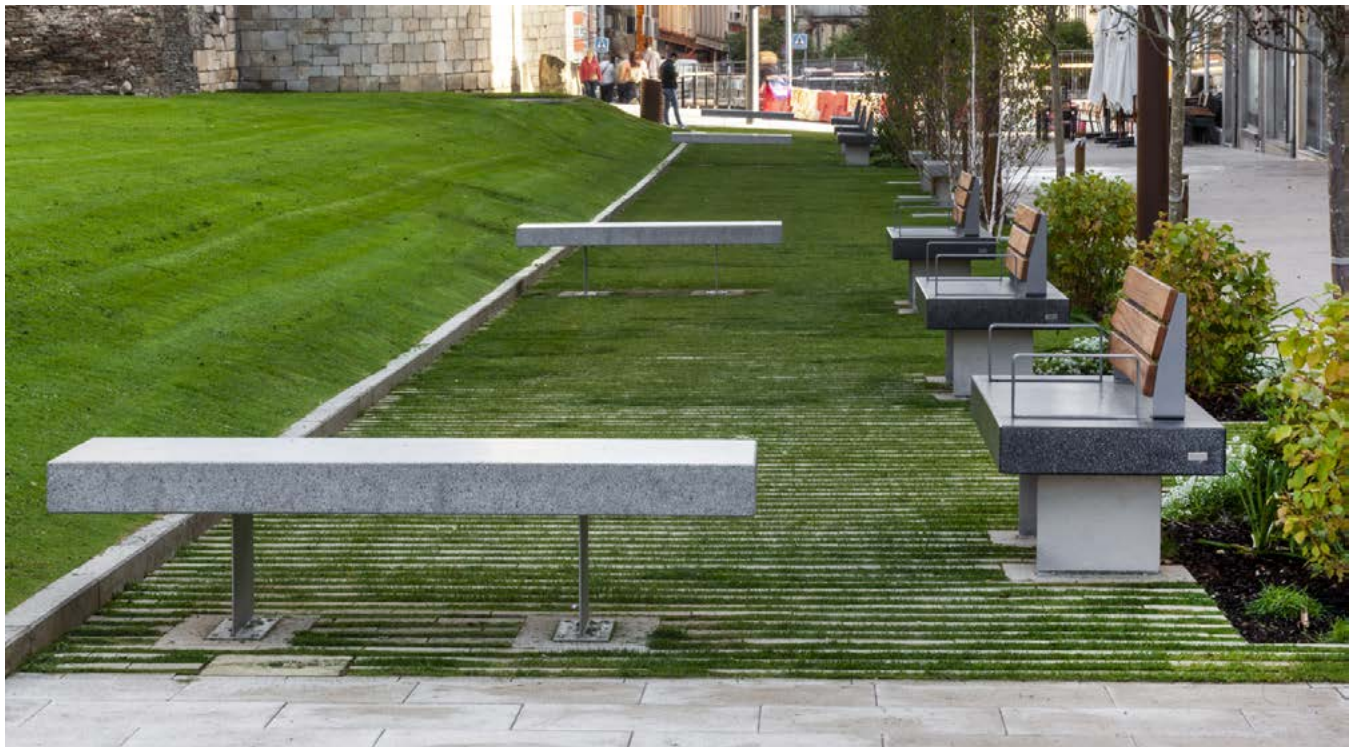

Escofet®

2. Dossier générique

Rest Dossier	150	300
Dimensions	150 x 13 x 41 cm	300 x 13 x 41 cm

Poids	15 kg	28 kg
--------------	-------	-------

1.1 Caractéristiques générales

Matériel	Acier zingué Acier inoxydable	Pose	Ancré sur le banc
-----------------	----------------------------------	-------------	-------------------

Finition	Peinture couleur argent texturé ou RAL avec protection contre la corrosion pour une catégorie de corrosivité atmosphérique C5 selon la norme UNE-EN ISO 12944-2. / Grenailage		
-----------------	---	--	--

Listones	Bois Tropical Certifié FSC®	Finition	Traitées à l'huile
-----------------	-----------------------------	-----------------	--------------------

Couleurs



A. Bois Tropical Certifié FSC®

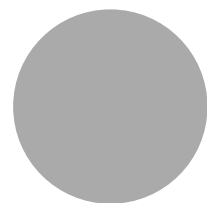

B. Acier argent texturé

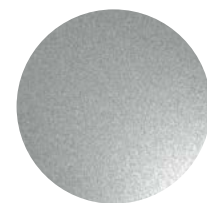

C. Acier inox. AISI 316

1.2 Géométrie

Rest Dossier 150

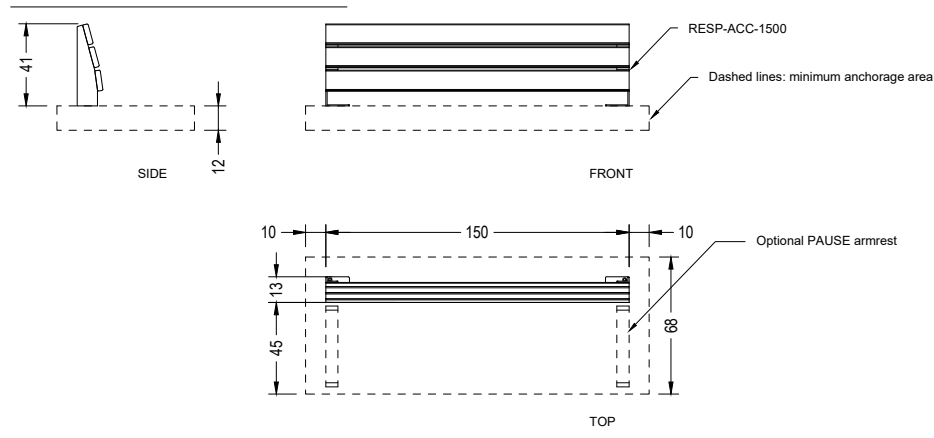

Rest Dossier 300

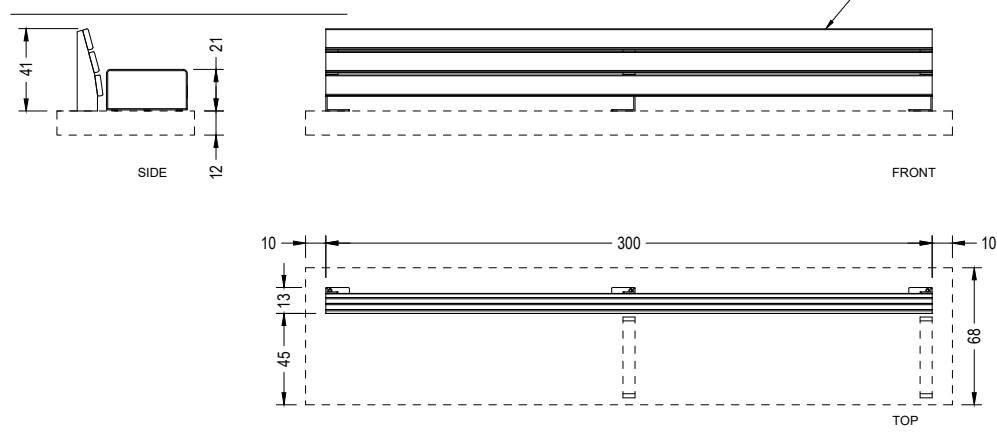

1.2 Système de pose

Rest Dossier

1. Centrez et positionnez l'accessoire sur le banc ou le mur et marquez les trous.
2. Percez le banc ou le mur et insérez la cheville à expansion filetée.

3. Positionner l'accessoire et visser les vis M-10.
4. Incorpore les rondelles en nylon pour séparer l'accoudeoir du support.

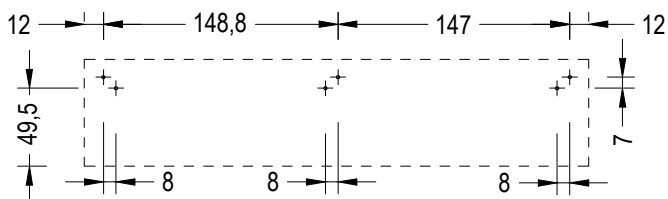
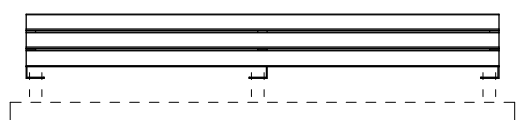
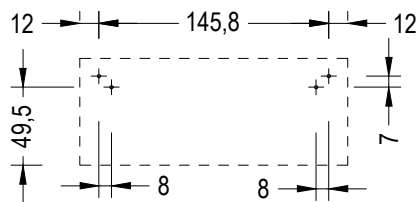
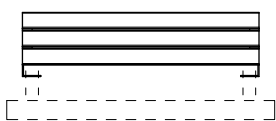

1.4. Compatibilité Rest Dossier

SOCRATES + RESPALDO

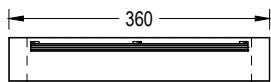
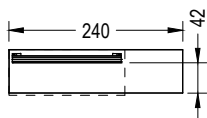

BANCALOSA + BACKREST



GODOT + BACKREST

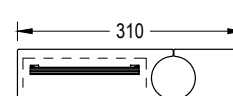
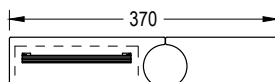
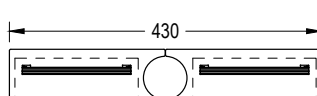

LONGO + BACKREST

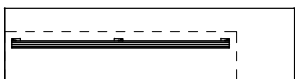
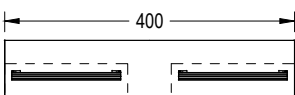

LEVIT + BACKREST

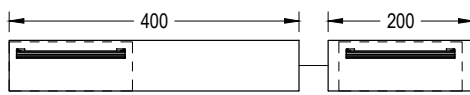

GENEVE + RESPALDO

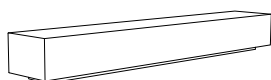
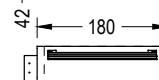
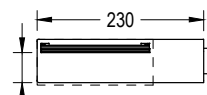

Sócrates

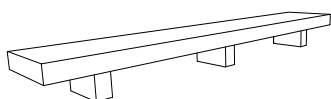

Bancalosa

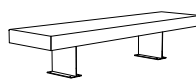

Levit

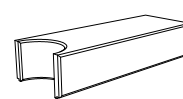

Godot



Longo

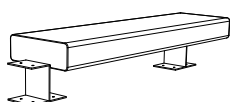

Geneve



Les noms, marques et modèles industriels des produits ont été déposés au registre correspondant. Les informations techniques de ce document peuvent être modifiées sans préavis.

Escofet 1886 S.A
Siège et production

Montserrat, 162
E 08760 Martorell
Barcelona - España
T. 0034 937 737 150
F. 0034 937 737 151

info@escofet.com
www.escofet.com



GA-2005/0072 SST-0090/2010 ER-0403/2016