

## CARACTERÍSTICAS / CHARACTERISTICS

**MATERIAL** acero zincado  
acero inoxidable

**MATERIAL** zinc plated steel  
stainless steel

**ACABADO** pintado plata texturizado  
pintado carta RAL

**FINISH** textured silver coated  
RAL chart coated

**COLOC.** anclado con tacos de expansión

**FIXING** anchored with expansion bolts

**PESO** 3,25kg

**WEIGHT** 3,25kg

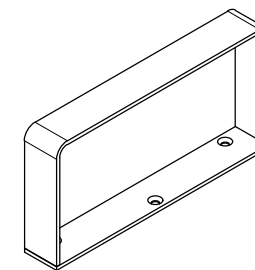

Update 11/10/2024  
Cotas / Sizes cm

## INSTALACIÓN / INSTALLATION

Centrar y colocar el accesorio sobre el banco o muro y marcar agujeros colisos

Center and place the accessory on the bench or retaining wall and mark the slotted holes

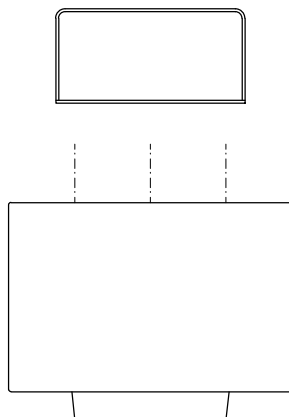

Taladrar el banco o muro y situar el accesorio  
Drill bench or retaining wall and place the accessory

Insertar y roscar los 3 tacos de expansión 8 x 45mm  
Insert and tightly 3 expansion bolts 8 x 45mm

Incorpora arandelas de nylon para separar el apoyabrazos del soporte  
Includes nylon washers to separate the armrest from the support

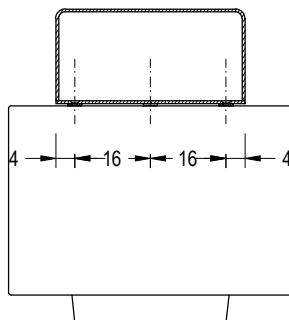

## GEOMETRÍA / GEOMETRY

E:1/16

E:1/8

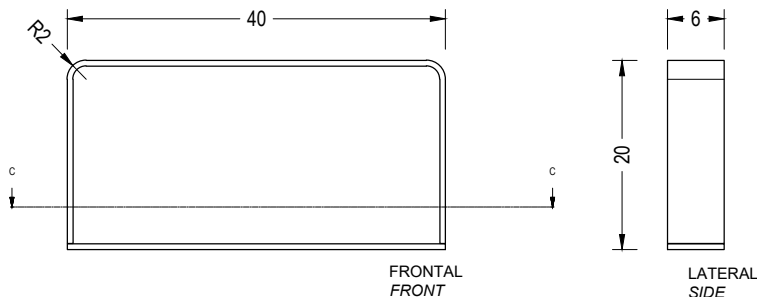

FRONTAL  
FRONT

LATERAL  
SIDE

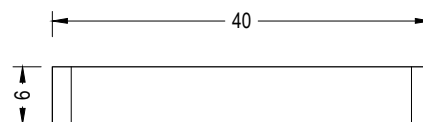

PLANTA  
TOP

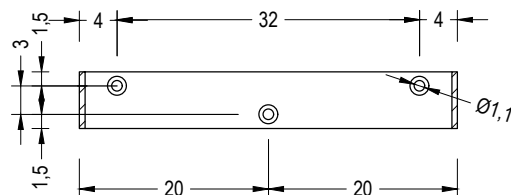

SECCIÓN  
SECTION

SOCRATES + REST

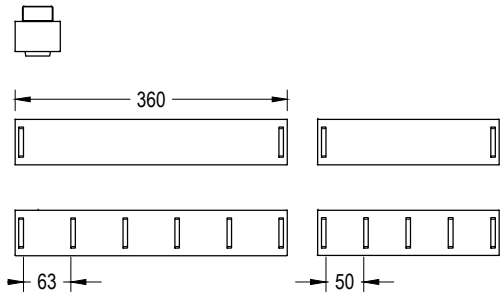

BOX + REST

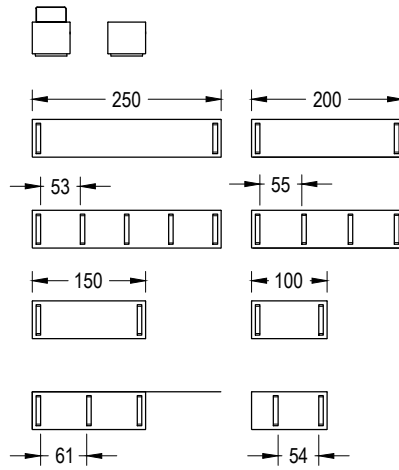

PORTIC + REST

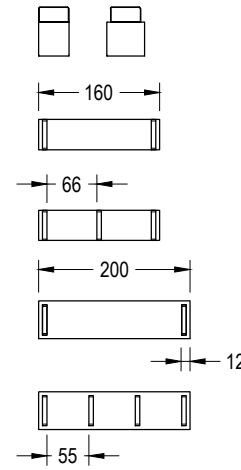

GARONNE + REST

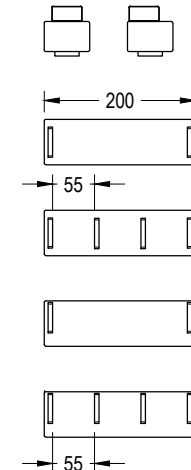

GENEVE + REST

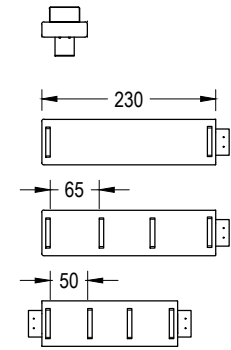

COMU + REST

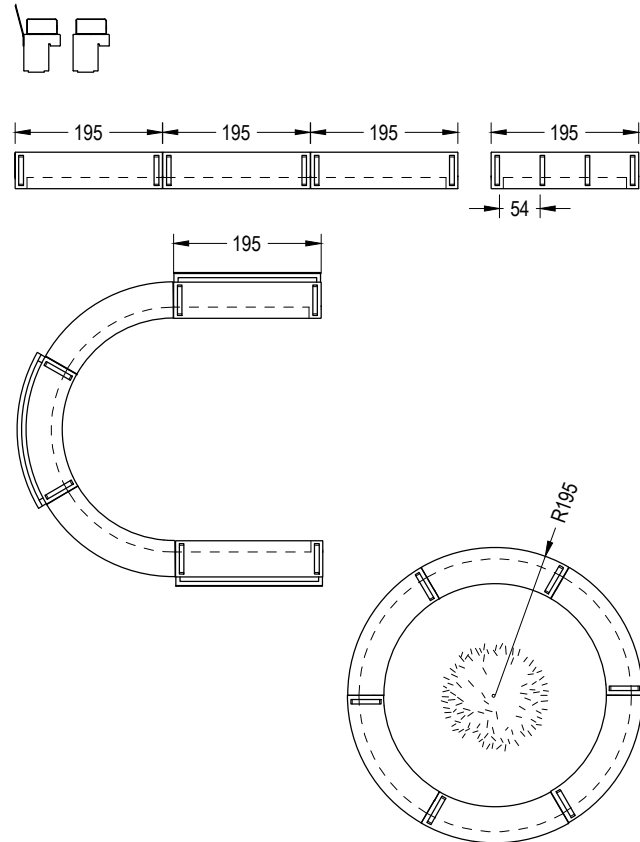

GODOT + REST

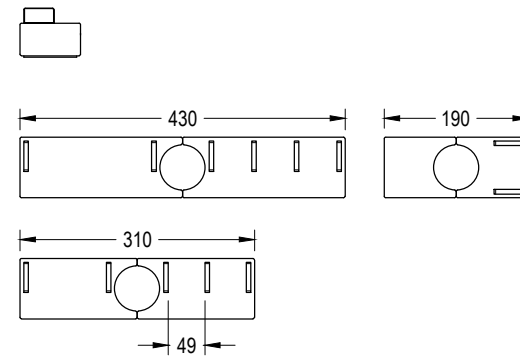

BANCALOSA + REST

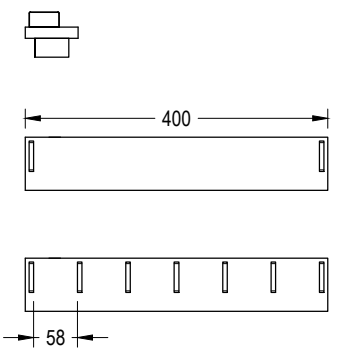

LONGO + REST

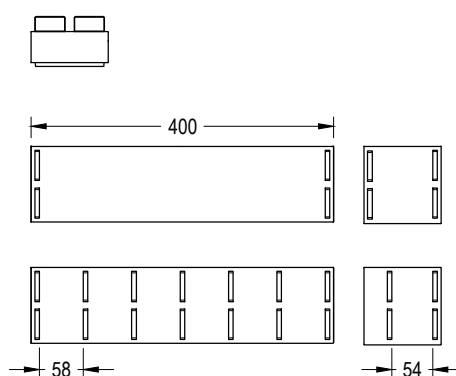

LEVIT + REST

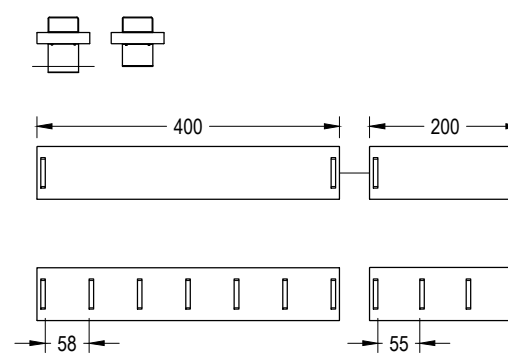

BAND + REST

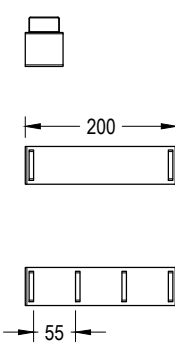

**CARACTERÍSTICAS / CHARACTERISTICS**

**MATERIAL** madera tropical certificada FSC®  
**ACABADO** tratada con aceite  
**SOPORTE** acero zincado /  
 acero inoxidable  
**ACABADO** pintado plata texturizado /  
 granallado  
**COLOC.** anclado con tornillos y embrafix  
**PESO** 15 kg / 28 kg

**MATERIAL** tropical wood FSC® certificate  
**FINISH** oil-treated  
**SUPPORT** zinc plated steel /  
 stainless steel  
**FINISH** textured silver coated /  
 shotblasted  
**FIXING** anchored with screws and embrafix  
**WEIGHT** 15 kg / 28 kg

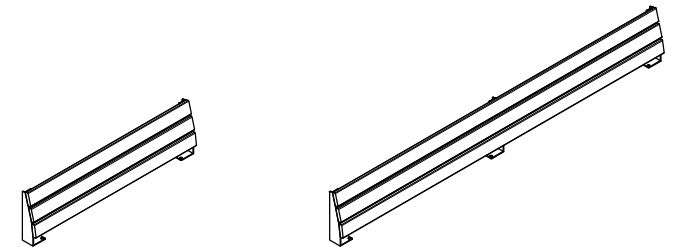

Update 11/10/2024  
 Cotas / Sizes cm

**INSTALACIÓN / INSTALLATION**

Centrar y colocar el accesorio sobre el banco o muro  
 y marcar agujeros colisos  
*Center and place the accessory on the bench or  
 retaining wall and mark the slotted holes*

E:1/16

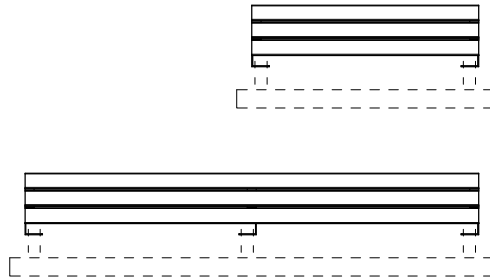

Taladrar el banco o muro y insertar anclaje roscado de expansión  
*Drill bench or retaining wall and insert the threaded expansion anchor*

Situar el accesorio y rosar los tornillos M-10  
*Place the accessory and tightly the M-10 screws*

Incorpora arandelas de nylon para separar el accesorio del soporte  
*Includes nylon washers to separate the accessory from the support*

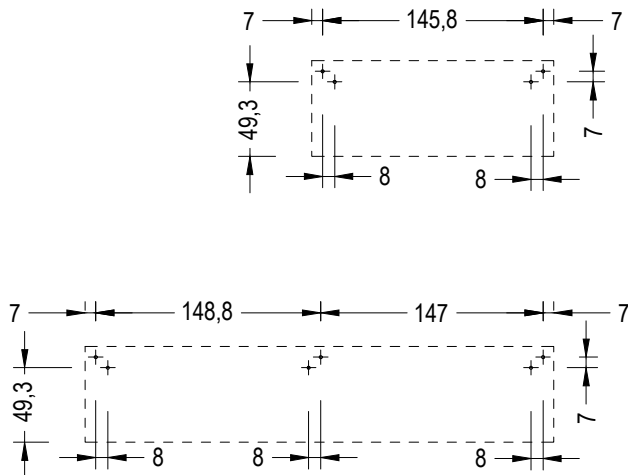

**GEOMETRÍA / GEOMETRY**

**REST respaldo 1500 / backrest 1500**

E:1/8

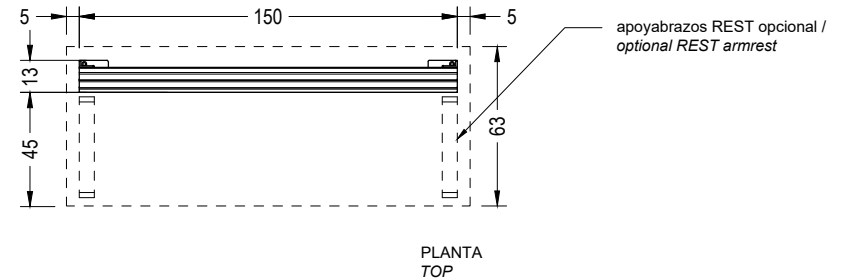
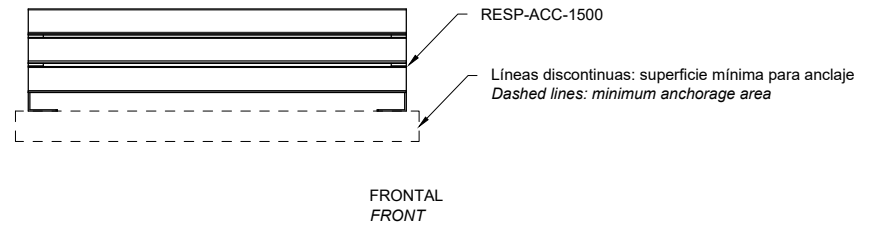
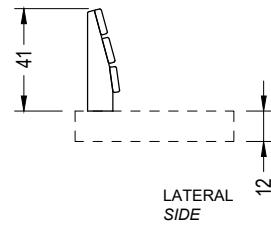

**REST respaldo 3000 / backrest 3000**

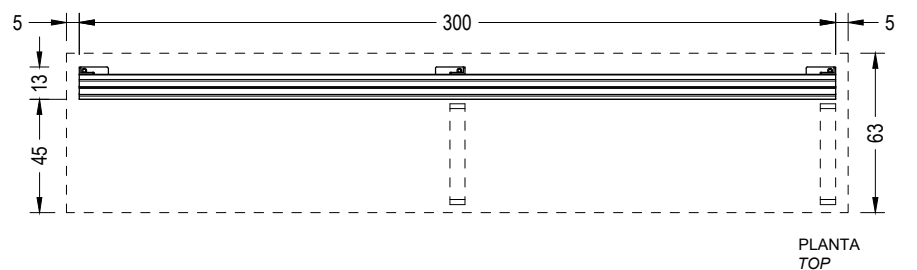
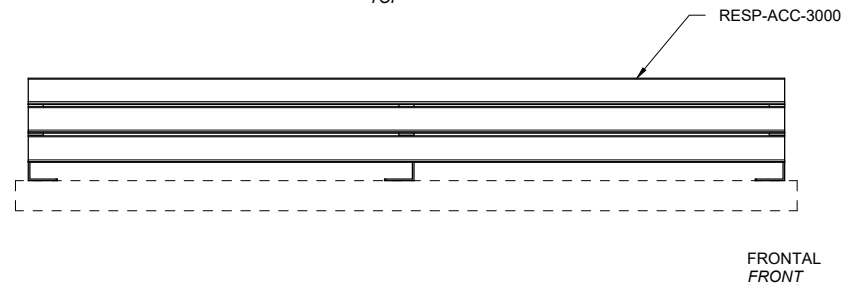
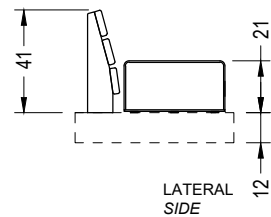

SOCRATES + RESPALDO

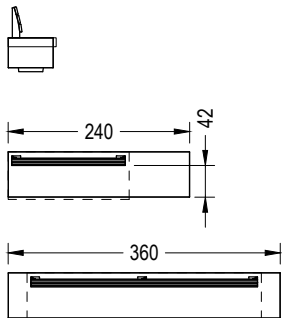

GODOT + RESPALDO

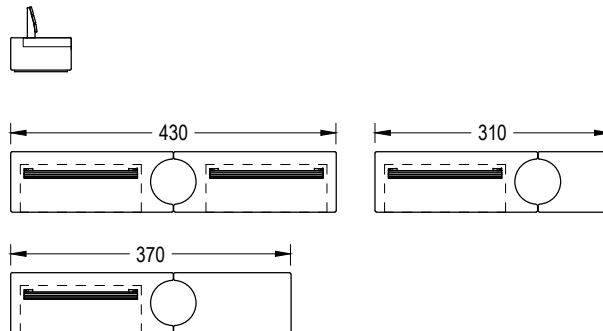

BANCALOSA + RESPALDO

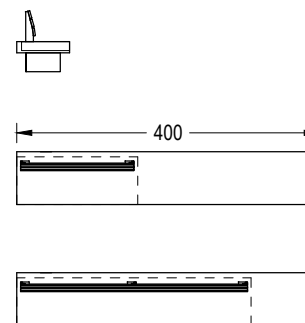

LONGO + RESPALDO

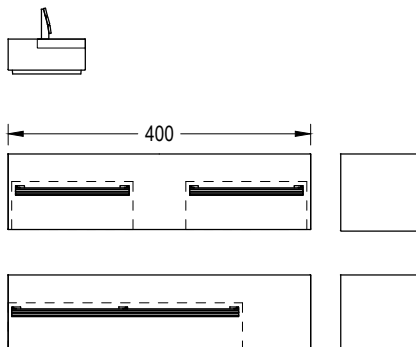

LEVIT + RESPALDO

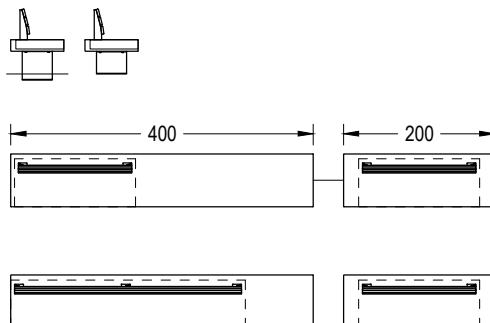

GENEVE + RESPALDO

