

The 560 L, 950 L HIDROJARDINERA (Hidro Planters) concrete monobloc are characterised by the appropriate incorporation of a self-watering system into their design. They were designed with the objective of creating planters in several sizes to permit the planting and growth of average-sized trees and the possibility of moving them with forklift or pallet truck without having to empty the contents.

Concrete | 130 cm |  1180 kg |  950 L

 Update 28.10.2024



HIDROJARDINERA

Eric Pericas 1999

Escofet
by Molins[®]

ORIGIN

The 560 L and 950 L HIDROJARDINERAS, were created within the framework of a collaborative agreement between Escofet and the Barcelona Municipal Institute of Parks and Gardens.

SUSTAINABLE

The 560 L and 950 L HIDROJARDINERAS have a built-in hydroponic watering system that reduces the watering frequency. The system consists of a lower water storage tank in which the level is regulated by a relief valve, a HPL separator plate perforated by cotton wicks that suction the water by capillarity and two vertical ducts that ventilate the tank, emerging above the top level of soil to prevent water putrefaction. The two pipes are protected by perforated plugs to prevent the intrusion of objects.

IRRIGATION

Large volume irrigation by surface flooding. The excess water is stored in the lower cistern up to its maximum level regulated by the two overflows.

FUNCTIONALITY

Its cubic geometry lends strength to its structure, allowing it to be moved even when filled with soil, without affecting the plants that grow inside it.

MATERIAL

Monomaterial body of concrete reinforced with stainless steel. Etched, water-repellent finish. Supplied in all the Escofet standard chart colours.

INSTALLATION

Self-standing and installed directly on the paving on the four support legs built into the concrete volume, with no need for anchors.



HIDROJARDINERA

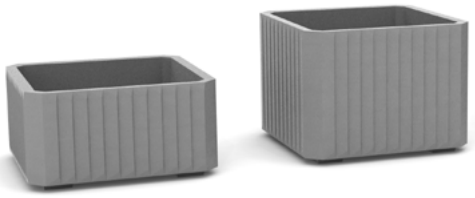

1. Planter

Hidrojardinera	560 L (without self-watering)	950 L (without self-watering)	560 L (self-watering)	950 L (self-watering)
Dimensions	130 x 130 x 66 cm	130 x 130 x 96 cm	130 x 130 x 66 cm	130 x 130 x 96 cm
Weight	870 kg	1180 kg	870 kg	1180 kg
Capacity	560 L	950 L	560 L	950 L

1.1 General features

Material	Reinforced concrete	Fixing	Free-standing
Finish	Etched and waterproofed		

Colours

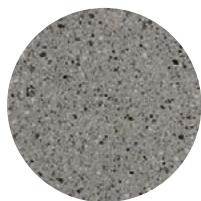

GR. Grey

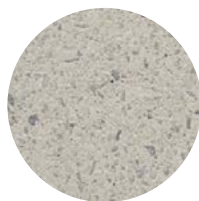

BL. White

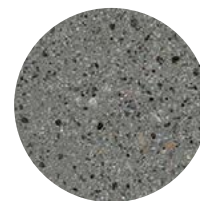

CA. CA Grey

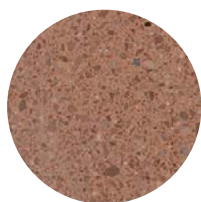

RA. Red

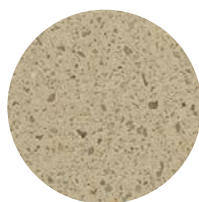

BG. Beige

1.2 Installation system

Hoisting

W= 870 kg / 1180 kg

weight with soil W = 1822 kg / 2795 kg

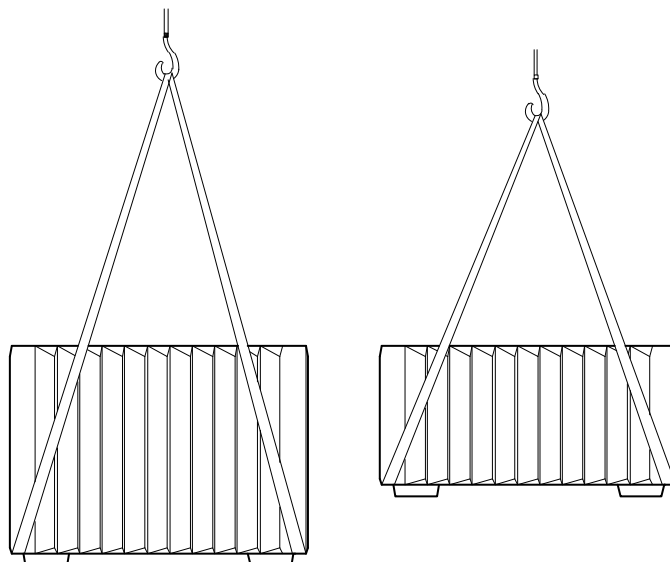

1.2 Installation system

Conventional planting

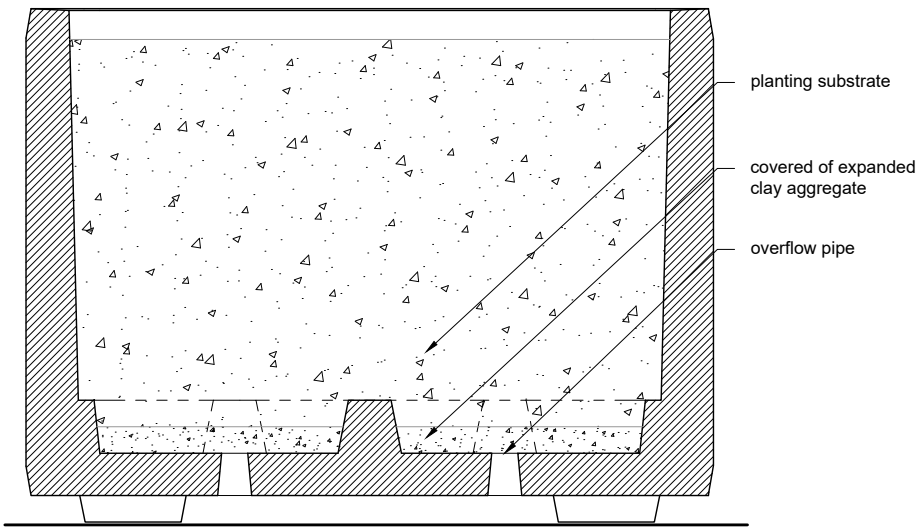

Capillarity irrigation system

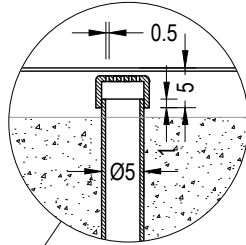
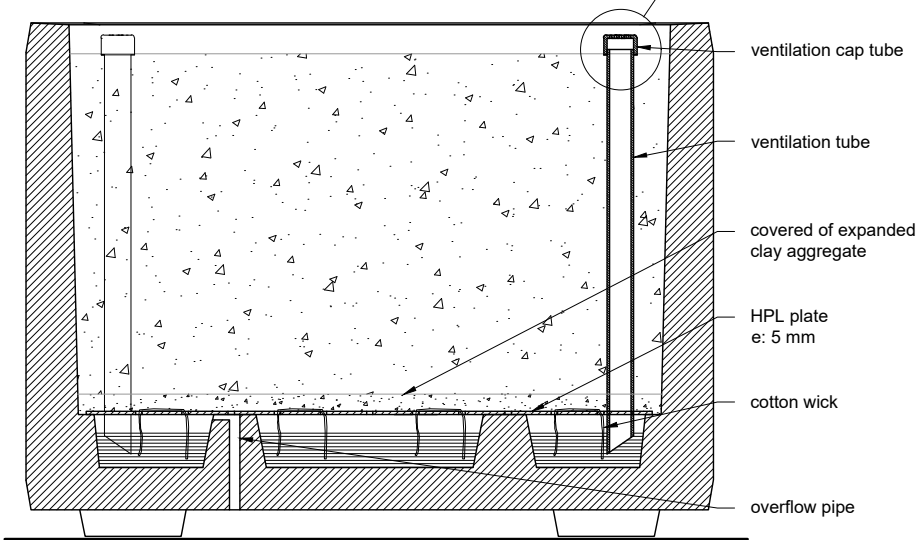

1.3 Geometry

Hidrojardinera 560 L (self-watering)

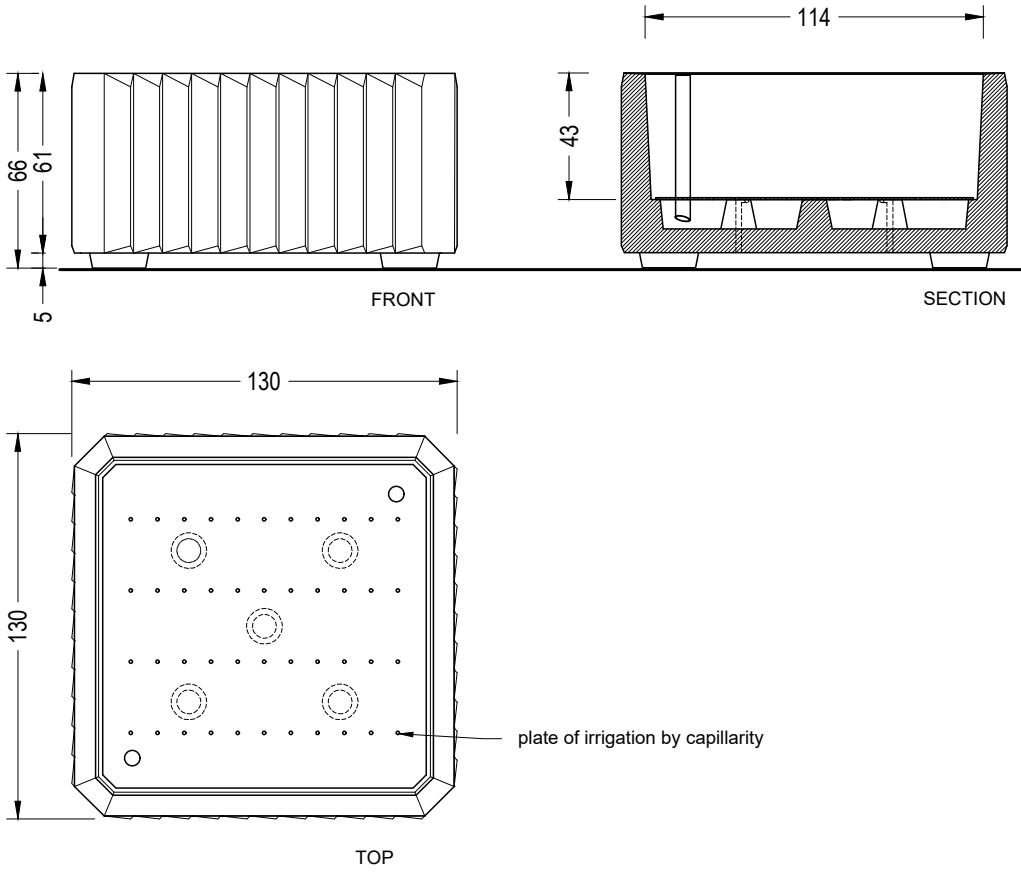

Hidrojardinera 950 L (self-watering)

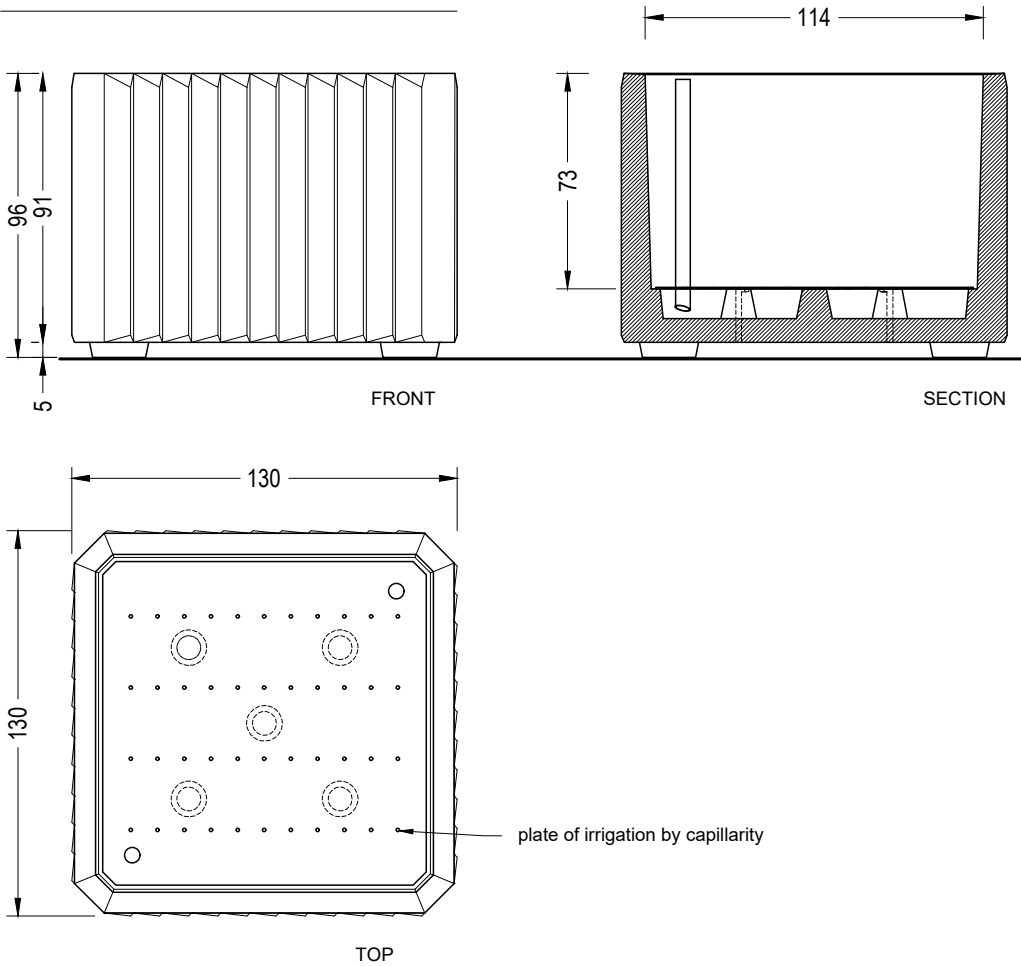

1.3 Geometry

Hidrojardinera 560 L (without self-watering)

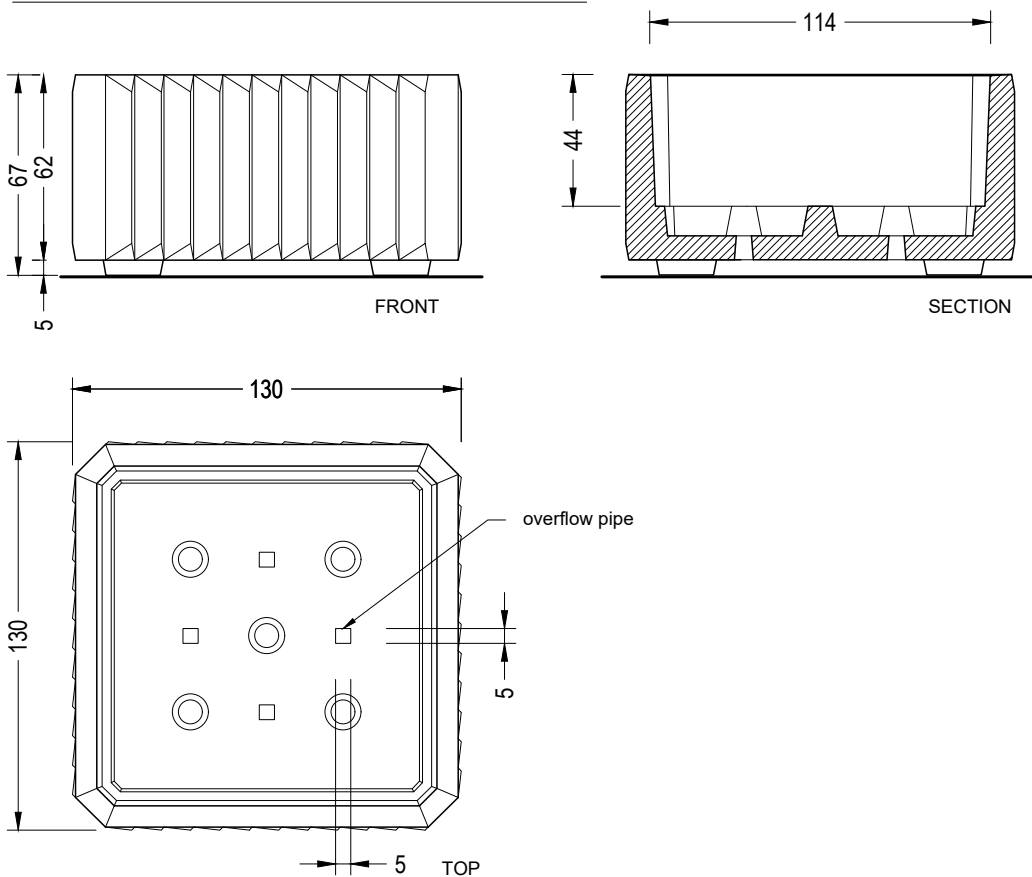

Hidrojardinera 950 L (without self-watering)

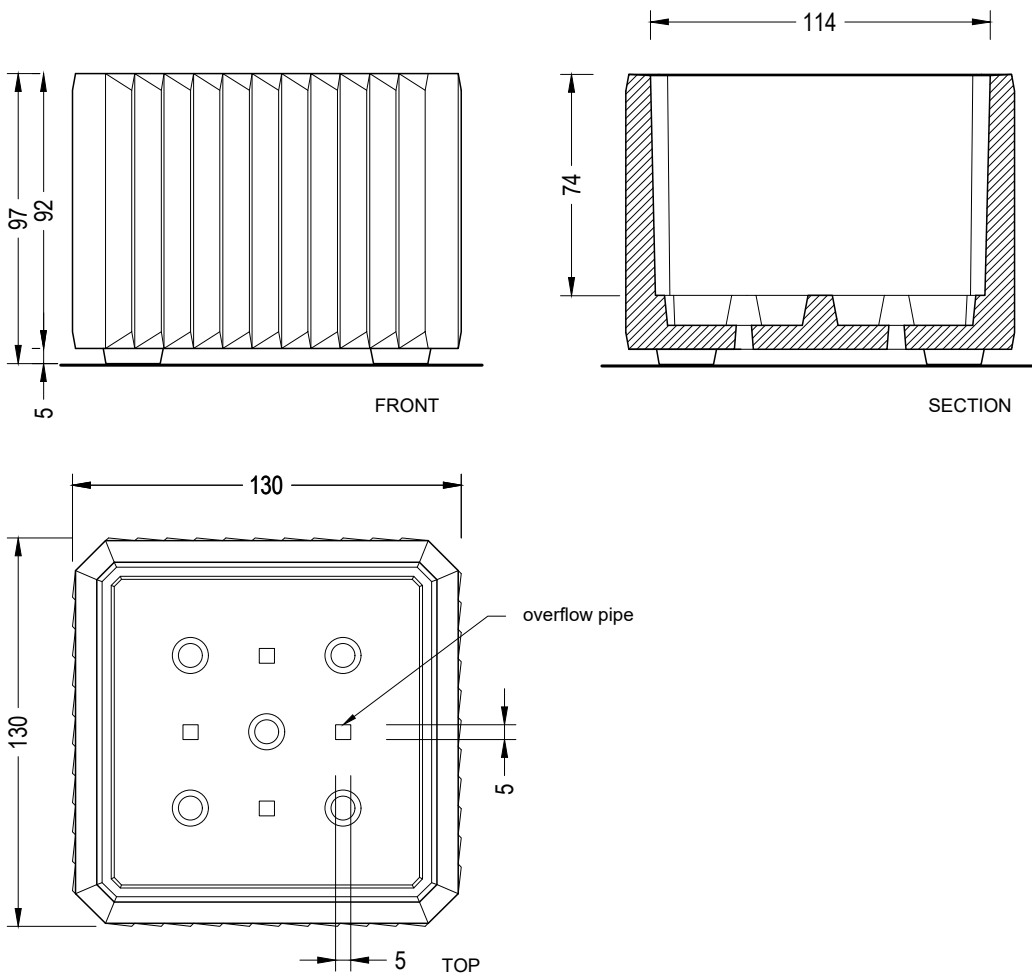

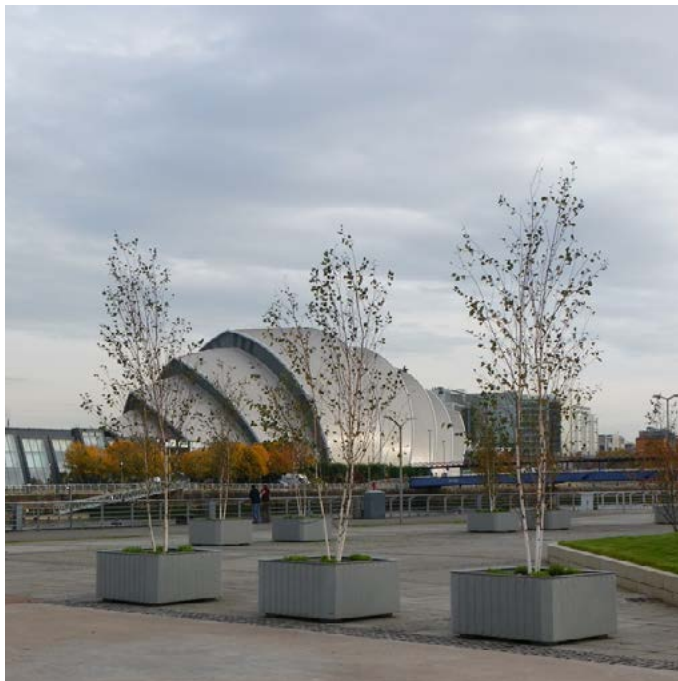

Warranty

5 years in concrete elements.

The names, trademarks and industrial models of the products have been logged in the corresponding registers. The technical information provided by Escofet about its products can be modified without prior notice.

Escofet 1886 S.A
Head office and production

Montserrat, 162
E 08760 Martorell
Barcelona - España
T. 0034 937 737 150
F. 0034 937 737 151

info@escofet.com
www.escofet.com

Escofet
by Molins[®]

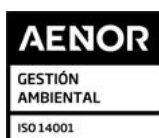

GA-2005/0072



SST-0090/2010



ER-0403/2016

