

ABRIL

ABRIL is a reinforced concrete, self-standing element that requires no anchors. The beauty of this bench lies in the mirage of its apparent simplicity, formalised as an arch and with a minimum slab edge in contrast with the large dimension of its supporting pilasters, thus emphasising the wide opening between its supports.

Concrete |  296 cm |  1100 kg max. |  10

 Update 23.07.2024



Cruz y Ortiz 1990

Escofet
by Molins[®]

ORIGIN

The architects Cruz and Ortiz created their first design for Escofet, which they called Abril, and was then completed with Mayo and Junio. This is how Abril opened up the path for a new generation of neutral, abstract elements for universal use that eventually took on the condition of a basic vocabulary in building a language hitherto unknown.

DESIGN

A design that is rigorous and simple in terms of its formulation, but universal in terms of its application. An element that is self-explanatory, that focuses, marks, locates and organises space. Well related to the terrain and the horizontal plane.

MATERIAL

Bench made from reinforced, etched, water-repellent concrete in the Escofet standard colour chart.

INSTALLATION

Self-standing, with no need for anchors.



ABRIL



1. Backless bench

Abril

Dimensions 45 x 296 x 75 cm

Weight 1100 kg

1.1 General features

Material Concrete Recycled concrete **Fixing** Free-standing

Finish Etched and waterproofed

Colours

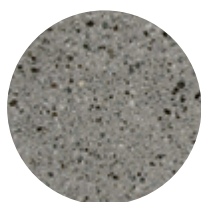

GR. Grey

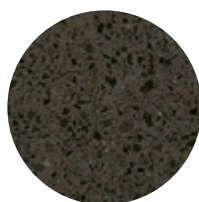

NG. Black

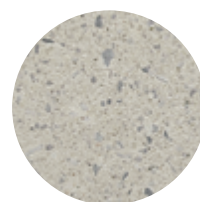

BL. White

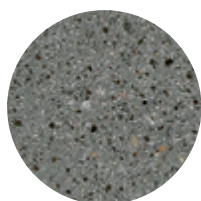

CA. Grey
CA

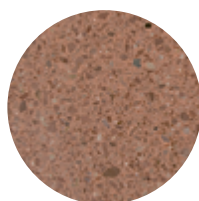

RA. Red

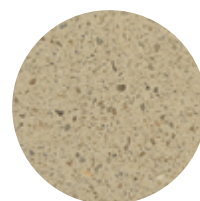

BG. Beige

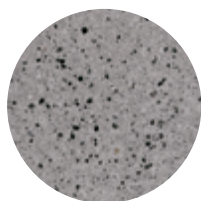

EGR. Eco-Grey®

1.2 Installation system

Hoisting

(P=1100 kg)

Installation

Unloading by fork-lift:

Lift bench by interposing wooden boards that support bench by means of two rests placed at 2 m distance from each other.

Unloading by crane:

Place slings so as distance between suspension points be at least of 2 m.

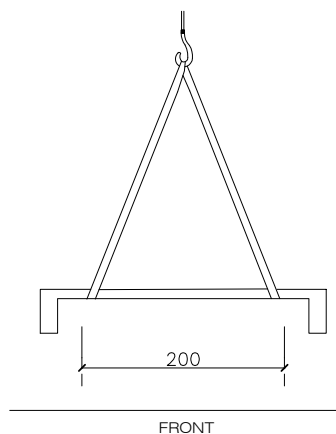
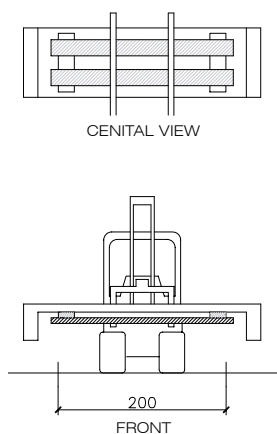

1.3 Geometry

Abril

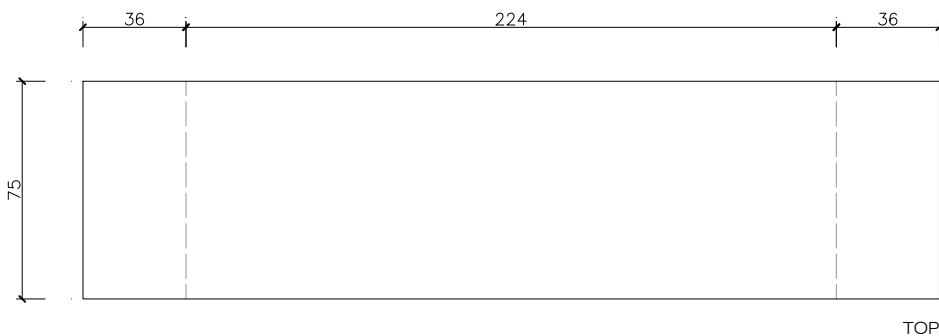
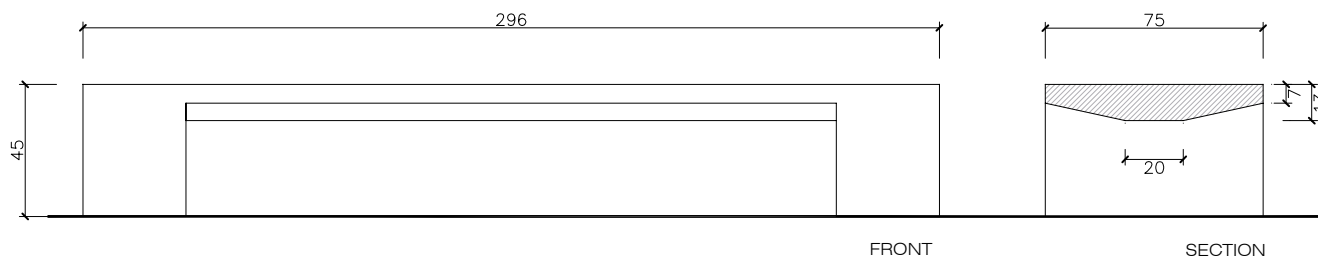



Warranty

5 years in concrete elements.

The names, trademarks and industrial models of the products have been logged in the corresponding registers. The technical information provided by Escofet about its products can be modified without prior notice.

Escofet 1886 S.A
Head office and production

Montserrat, 162
E 08760 Martorell
Barcelona - España
T. 0034 937 737 150
F. 0034 937 737 151

info@escofet.com
www.escofet.com

Escofet
by Molins[®]

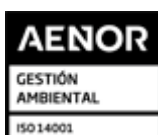

GA-2005/0072



SST-0090/2010



ER-0403/2016

