

CARACTERÍSTICAS / CHARACTERISTICS

MATERIAL acero zincado
acero inoxidable

MATERIAL zinc plated steel
stainless steel

ACABADO pintado plata texturizado
pintado carta RAL

FINISH textured silver coated
RAL chart coated

COLOC. anclado con tacos de expansión

FIXING anchored with expansion bolts

PESO 3,25kg

WEIGHT 3,25kg

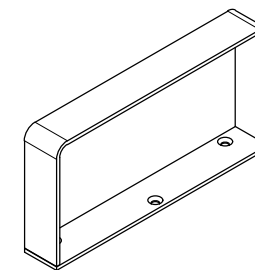

Update 25/01/2022
Cotas / Sizes cm

INSTALACIÓN / INSTALLATION

Centrar y colocar el accesorio sobre el banco o muro y marcar agujeros colisos

Center and place the accessory on the bench or retaining wall and mark the slotted holes

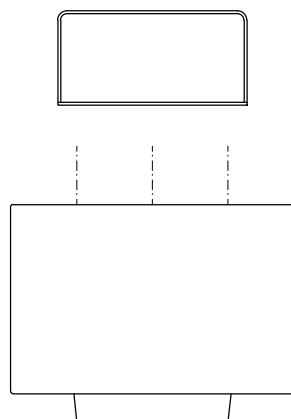

Taladrar el banco o muro y situar el accesorio
Drill bench or retaining wall and place the accessory

Insertar y roscar los 3 tacos de expansión 8 x 45mm
Insert and tightly 3 expansion bolts 8 x 45mm

Incorpora arandelas de nylon para separar el apoyabrazos del soporte
Includes nylon washers to separate the armrest from the support

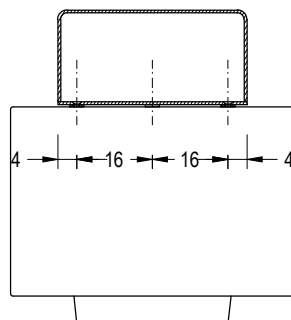

GEOMETRÍA / GEOMETRY

E:1/16

E:1/8

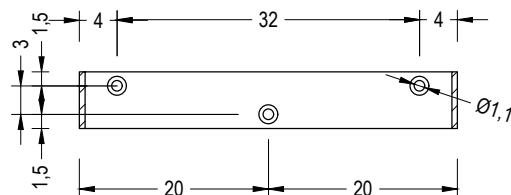
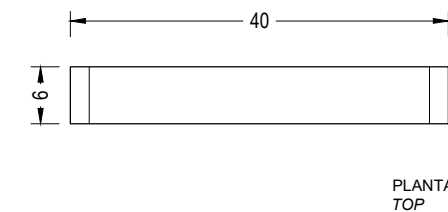
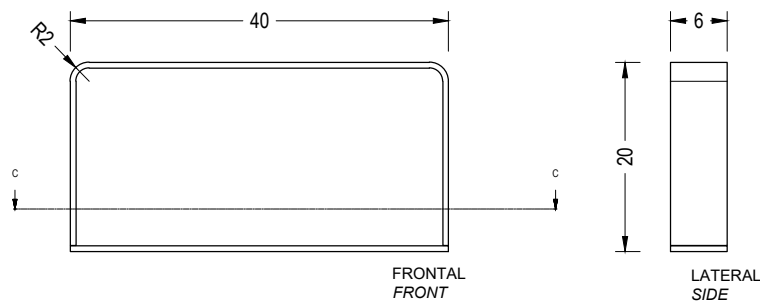

SECCIÓN
SECTION

SOCRATES + REST

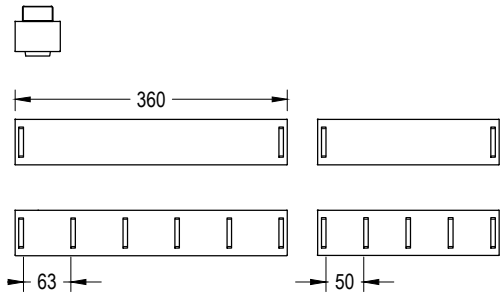

BOX + REST

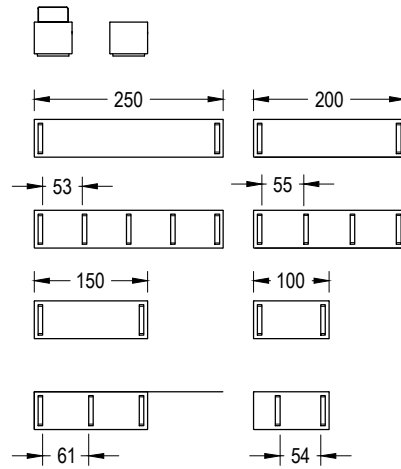

PORTIC + REST

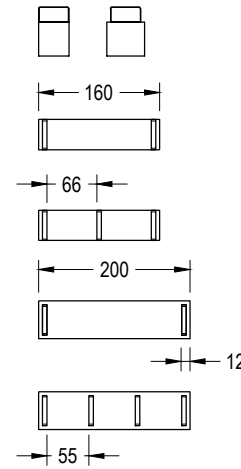

GARONNE + REST

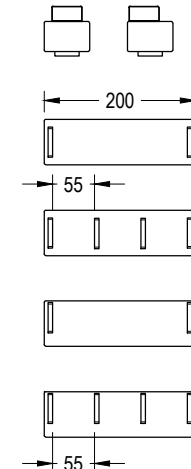

BARANA + REST

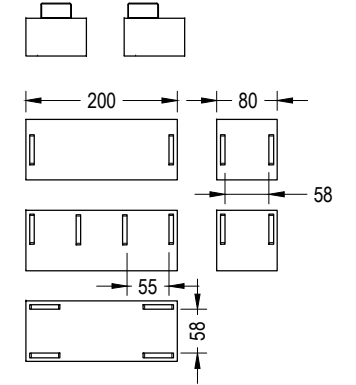

COMU + REST

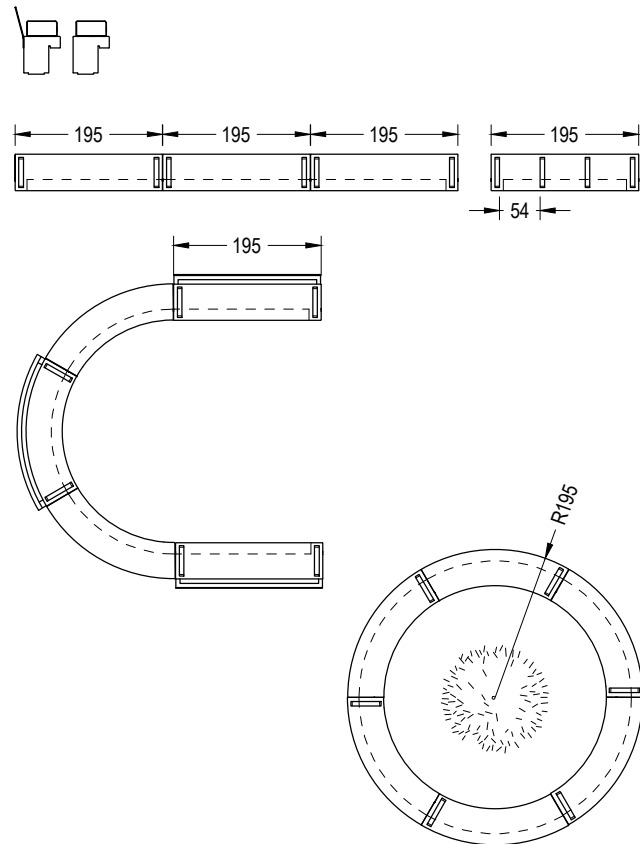

CANET + REST

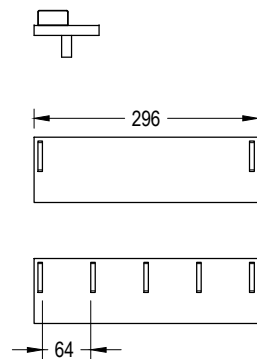

GODOT + REST

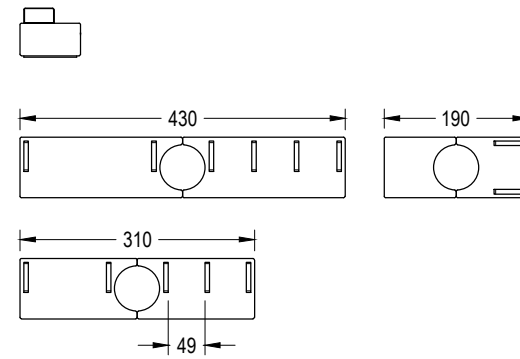

BANCALOSA + REST

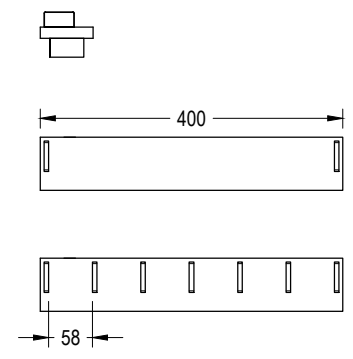

LONGO + REST

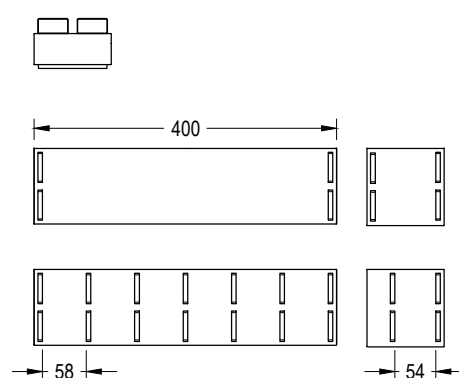

LEVIT + REST

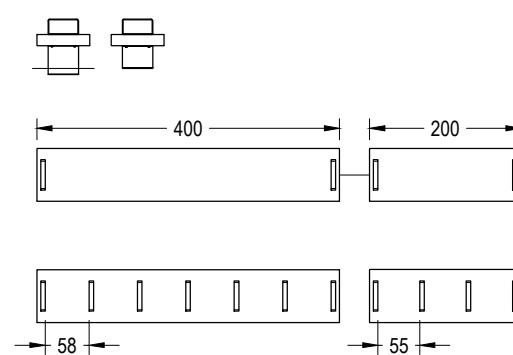

BAND + REST

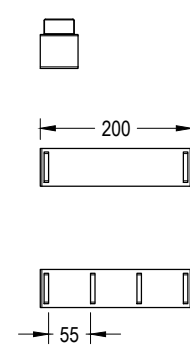

CARACTERÍSTICAS / CHARACTERISTICS

MATERIAL madera tropical certificada FSC®
 ACABADO tratada con aceite
 SOPORTE acero zincado /
 acero inoxidable
 ACABADO pintado plata texturizado /
 granallado
 COLOC. anclado con tornillos y embrafix
 PESO 15 kg / 28 kg

MATERIAL tropical wood FSC® certificate
 FINISH oil-treated
 SUPPORT zinc plated steel /
 stainless steel
 FINISH textured silver coated /
 shotblasted
 FIXING anchored with screws and embrafix
 WEIGHT 15 kg / 28 kg

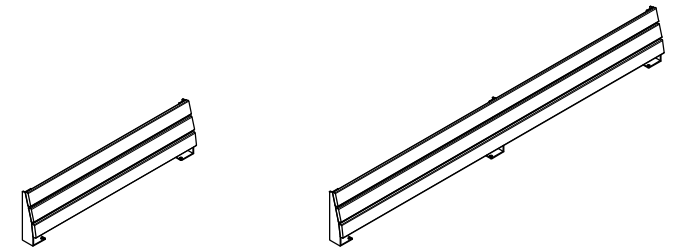

Update 29/11/2021
 Cotas / Sizes cm

INSTALACIÓN / INSTALLATION

Centrar y colocar el accesorio sobre el banco o muro
 y marcar agujeros colisos
*Center and place the accessory on the bench or
 retaining wall and mark the slotted holes*

E:1/16

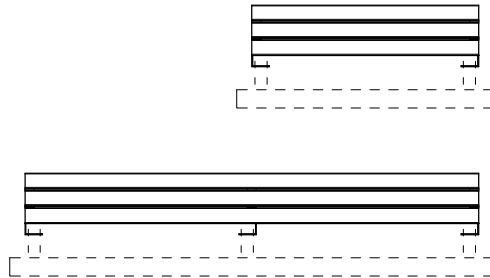

Taladrar el banco o muro y insertar anclaje roscado de expansión
Drill bench or retaining wall and insert the threaded expansion anchor

Situar el accesorio y rosar los tornillos M-10
Place the accessory and tightly the M-10 screws

Incorpora arandelas de nylon para separar el accesorio del soporte
Includes nylon washers to separate the accessory from the support

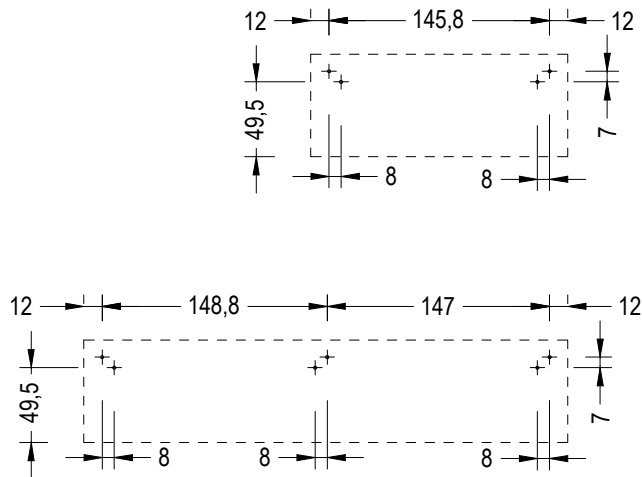

GEOMETRÍA / GEOMETRY

REST respaldo 1500 / backrest 1500

E:1/8

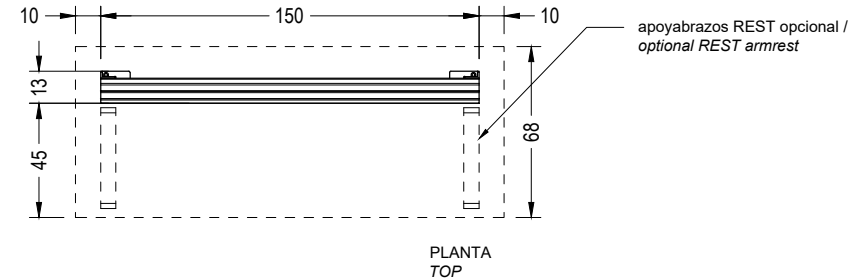
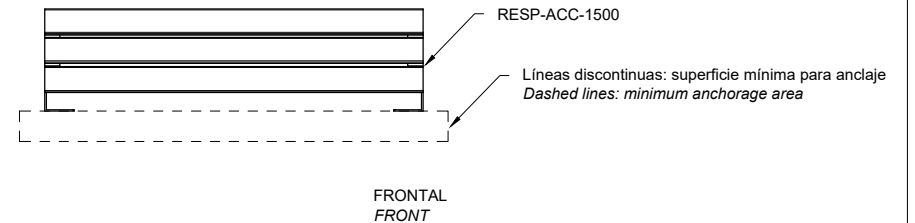
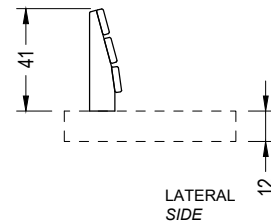

REST respaldo 3000 / backrest 3000

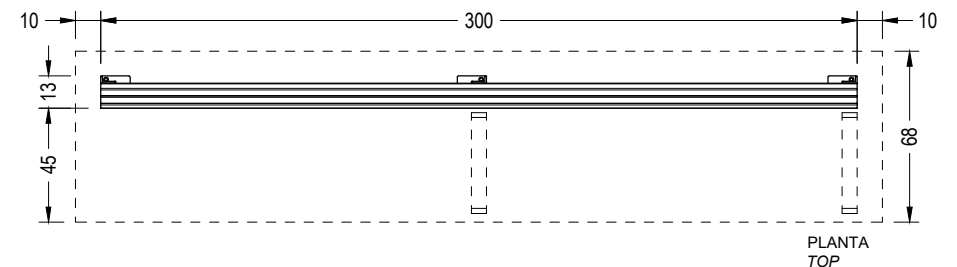
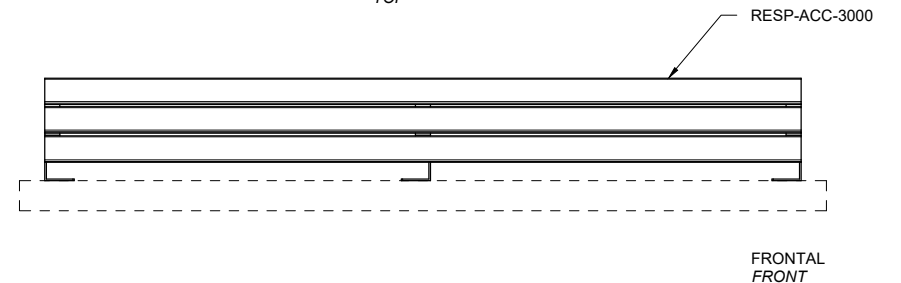
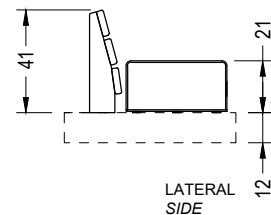

CANET + RESPALDO

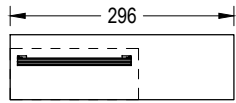

GODOT + RESPALDO

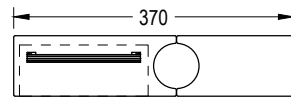
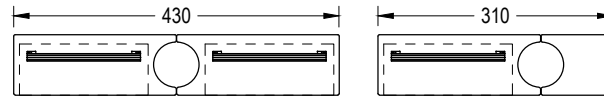

BANCALOSA + RESPALDO

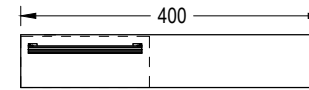

LONGO + RESPALDO

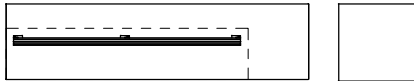
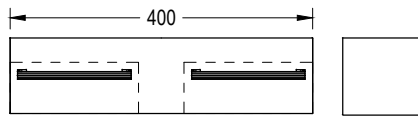

LEVIT + RESPALDO

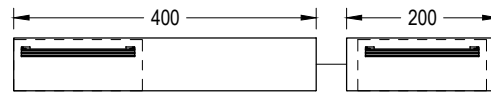
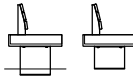

BARANA + RESPALDO

