

**CARACTERÍSTICAS / CHARACTERISTICS**

**MATERIAL** hormigón  
**COLOR** carta de colores estándar  
**ACABADO** pulido e hidrofugado /  
 decapado e hidrofugado  
**COLOC.** apoyado sin anclaje  
**PESO** banca 2670kg / cubo 725 kg

**MATERIAL** concrete  
**COLOUR** standard colour chart  
**FINISH** polished and waterproofed /  
 etched and waterproofed  
**FIXING** free-standing  
**WEIGHT** bench 2670 kg / cube 725 kg

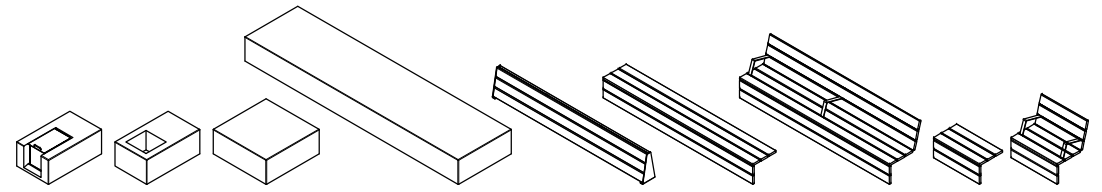

Update 12/02/2020  
 Cotas / Sizes cm

**INSTALACIÓN / INSTALLATION**

elevación / hoisting  
 P = 2670kg / 725 kg  
 elevación con eslingas de poliéster /  
 hoisting with polyester slings

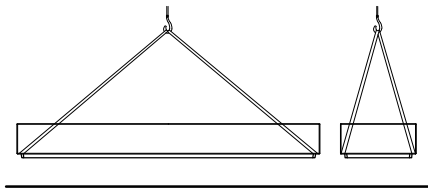

E:1/100

**GEOMETRÍA / GEOMETRY**

E:1/30

**LONGO BANCA**

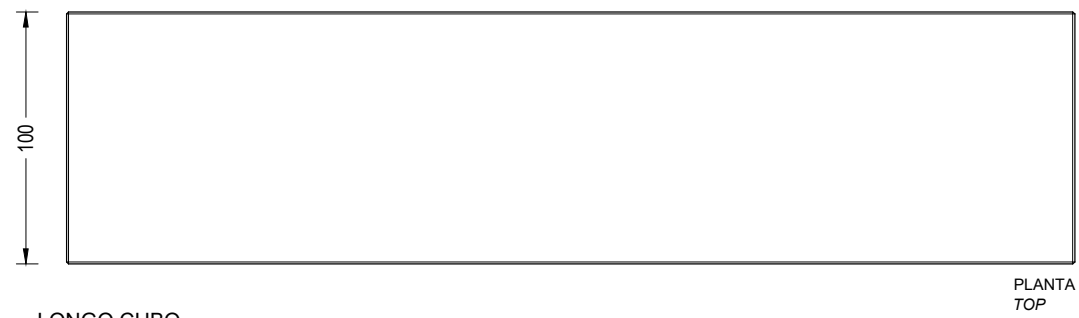
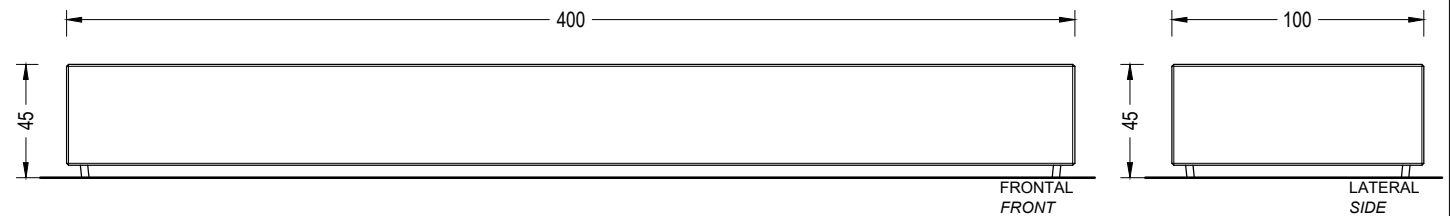

**LONGO CUBO**

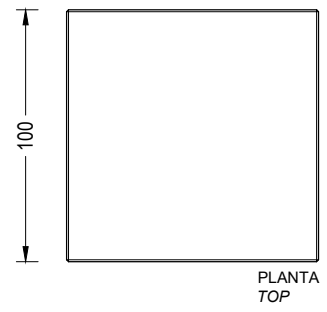
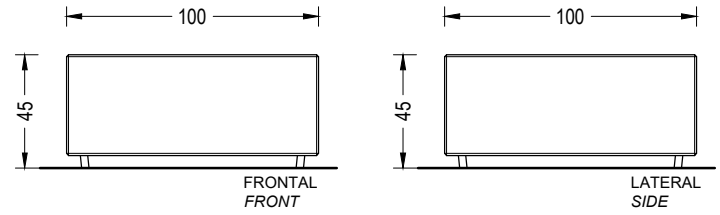

## CARACTERÍSTICAS / CHARACTERISTICS

**MATERIAL** hormigón  
**COLOR** carta de colores estándar  
**ACABADO** pulido e hidrofugado /  
 decapado e hidrofugado  
**COLOC.** apoyado sin anclaje  
**PESO** banca 2670kg / cubo 725 kg

**MATERIAL** concrete  
**COLOUR** standard colour chart  
**FINISH** polished and waterproofed /  
 etched and waterproofed  
**FIXING** free-standing  
**WEIGHT** bench 2670 kg / cube 725 kg

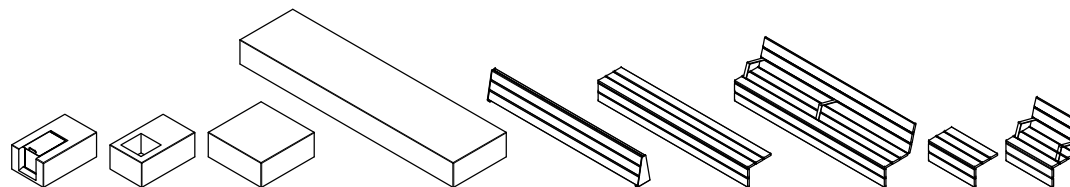

Update 08/02/2021  
 Cotas / Sizes cm

## INSTALACIÓN / INSTALLATION

E:1/40

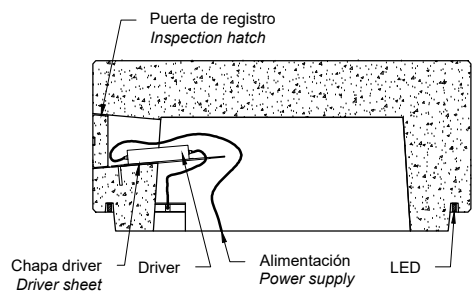

SECCIÓN REGISTRO  
 ELECTRICAL BOX SECTION

LED	
Tensión de trabajo <i>Operating voltage</i>	24V
Potencia <i>Power</i>	14 W/m
Temperatura de color <i>Color temperature</i>	4000K / 6000K
Grado de protección <i>Degree of protection</i>	IP67

Driver Vossloh o similar <i>Driver Vossloh or similar</i>	
Potencia <i>Power</i>	30W / 100W
Voltaje <i>Voltage</i>	220-240V
Frecuencia <i>Frequency</i>	50-60Hz
Factor de potencia <i>Power factor</i>	>0,9
Grado de protección <i>Degree of protection</i>	IP67

## GEOMETRÍA / GEOMETRY

E:1/30

### LONGO BANCA LED

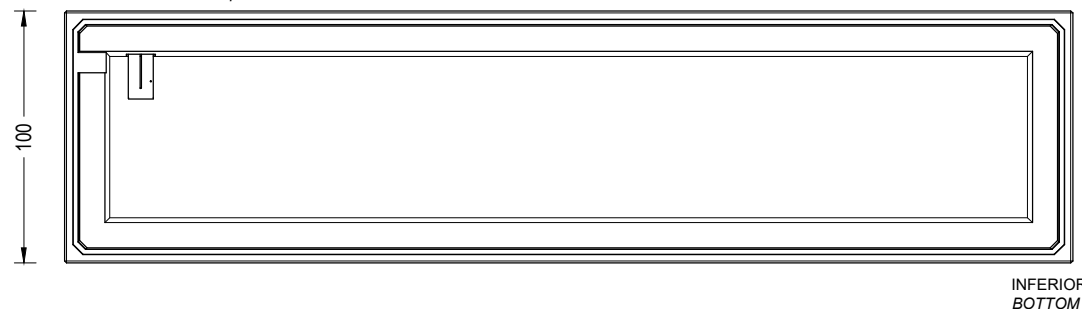
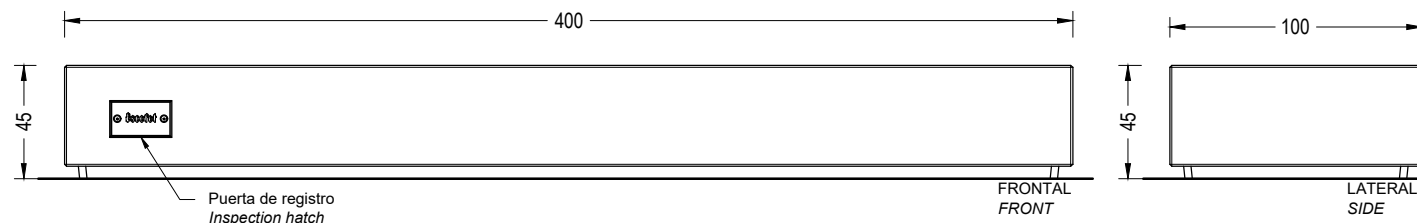

### LONGO CUBO LED

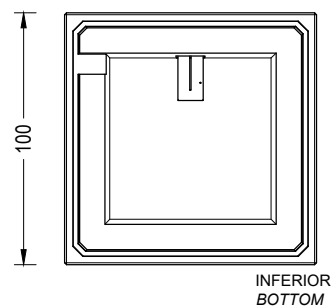
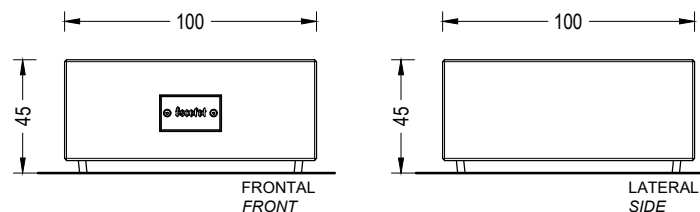

# CARACTERÍSTICAS / CHARACTERISTICS

**MATERIAL** hormigón  
**COLOR** carta de colores estándar  
**ACABADO** pulido e hidrofugado /  
 decapado e hidrofugado  
**ASIENTO** madera tropical certificada FSC®  
**ACABADO** tratada con lasur  
**REPOSA-** acero zincado  
**BRAZOS** pintado color plata texturizado  
**COLOC.** apoyado sin anclaje

**MATERIAL** concrete  
**COLOUR** standard colour chart  
**FINISH** polished and waterproofed /  
 etched and waterproofed  
**SEAT** tropical wood FSC® certified  
**FINISH** treated with lasur  
**ARMREST** zinc plated steel  
**FINISH** textured silver coated finish  
**FIXING** free-standing

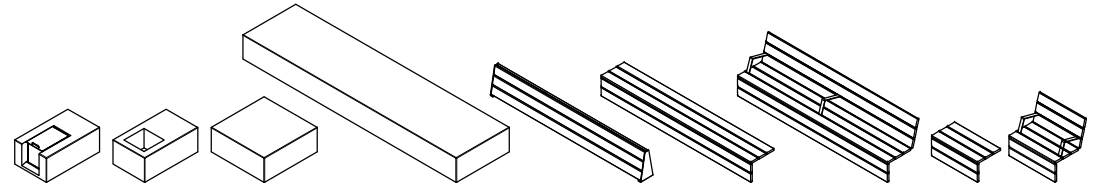

Update 08/02/2021  
 Cotas / Sizes cm

## AGREGACIÓN / AGGREGATION

E:1/200

1. Banca / Backless bench
2. Cubo / Cube
3. Accesorio Banco / Bench
4. Accesorio Banca / Backless bench
5. Accesorio Silla / Chair
6. Accesorio Asiento / Seat
7. Accesorio Respaldo doble / Double back
8. Papelera / Litter Bin
9. Cenicero / Ashtray

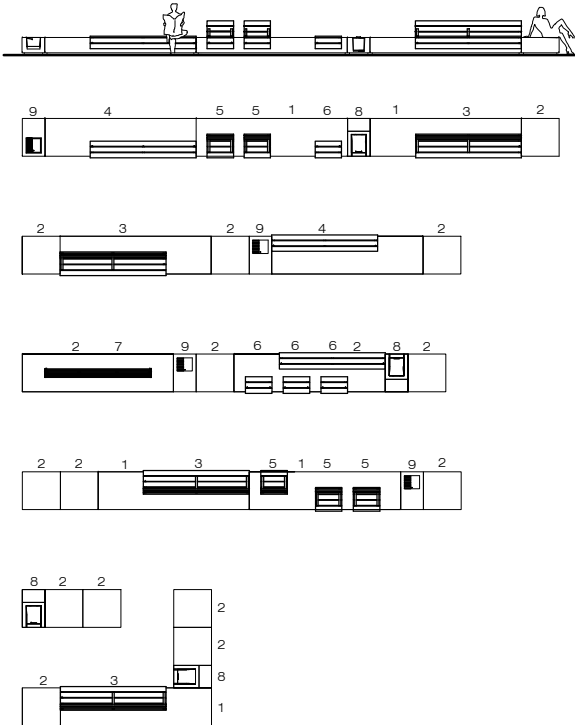

## GEOMETRÍA / GEOMETRY

E:1/40

LONGO BANCA + ACCESORIO BANCA + ACCESORIO ASIENTO (2730 kg)

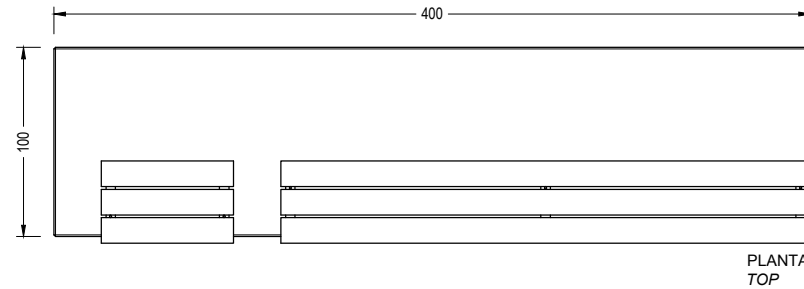
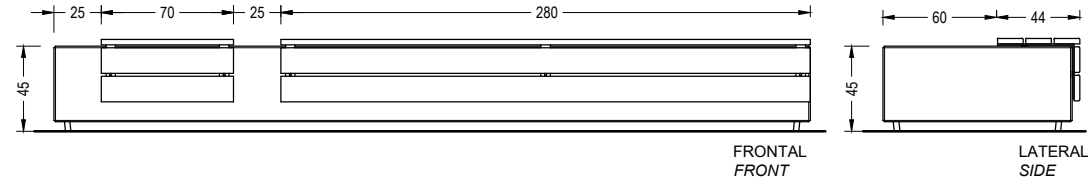

LONGO BANCA LED + ACCESORIO BANCO (2758 kg)

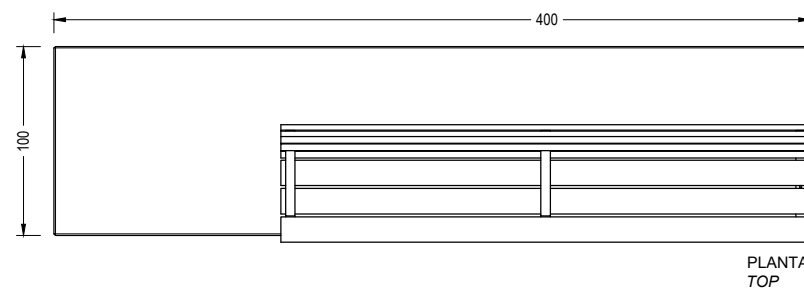
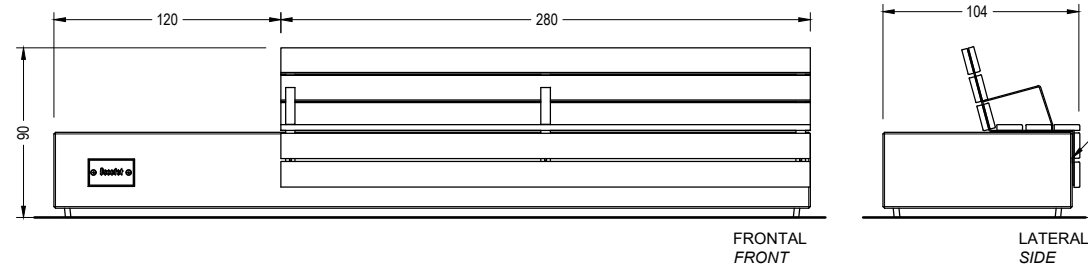

Incorpora arandelas de nylon para separar la madera del soporte /  
 Includes nylon washers to separate the wood from the support

## CARACTERÍSTICAS / CHARACTERISTICS

**MATERIAL** madera tropical certificada FSC®  
**ACABADO** tratada con lasur  
**SOPORTES** acero zincado / acero inoxidable  
**ACABADO** pintado color plata texturizado / inox  
**COLOC.** apoyado sin anclaje  
**PESO** acc. respaldo doble 60 kg

**MATERIAL** tropical wood FSC® certified  
**FINISH** treated with lasur  
**SUPPORTS** zinc plated steel / stainless steel  
**FINISH** textured silver coated finish  
**FIXING** free-standing  
**WEIGHT** acc. double back 60 kg

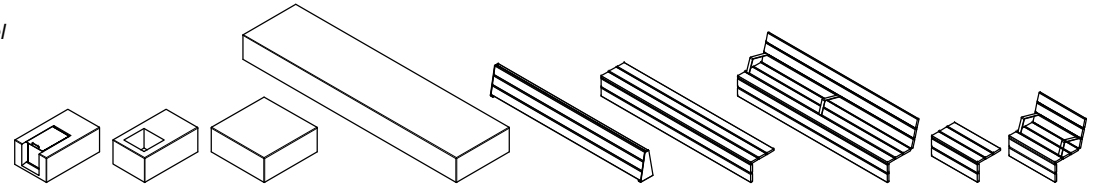

Update 09/02/2021  
Cotas / Sizes cm

## GEOMETRÍA / GEOMETRY

E:1/30

### LONGO BANCA + ACCESORIO RESPALDO DOBLE (2730 kg)

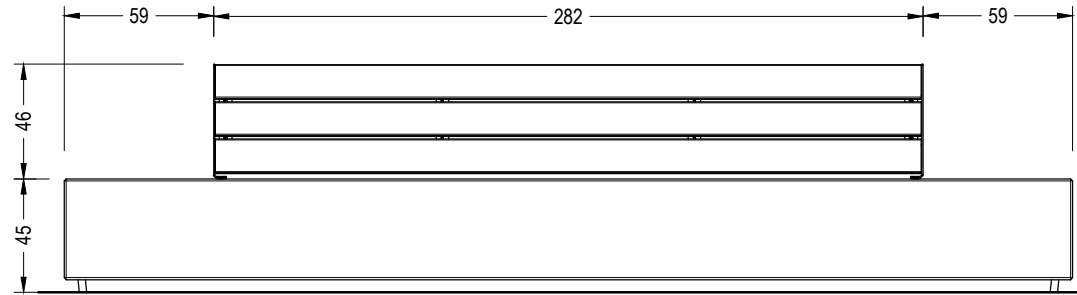

FRONTAL  
FRONT

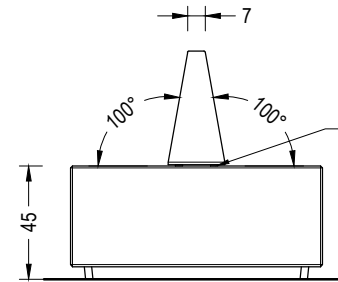

LATERAL  
SIDE

Incorpora arandelas de nylon para separar la madera del soporte / Includes nylon washers to separate the wood from the support

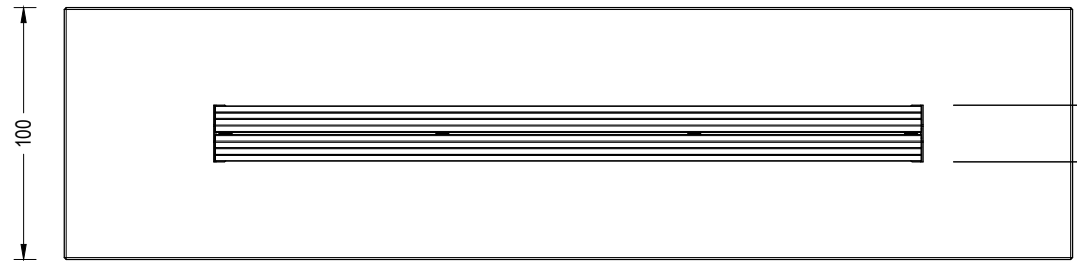

PLANTA  
TOP

# CARACTERÍSTICAS / CHARACTERISTICS

**MATERIAL** madera tropical certificada FSC®  
**ACABADO** tratada con lasur  
**SOPORTES** acero zincado / acero inoxidable  
**ACABADO** pintado color plata texturizado / inox  
**COLOC.** apoyado sin anclaje  
**PESO** acc. banca 43 kg  
 acc. banco 88 kg  
 acc. asiento 17 kg  
 acc. silla 34 kg

**MATERIAL** tropical wood FSC® certified  
**FINISH** treated with lasur  
**SUPPORTS** zinc plated steel / stainless steel  
**FINISH** textured silver coated finish  
**FIXING** free-standing  
**WEIGHT** acc. backless bench 43 kg  
 acc. bench 88 kg  
 acc. seat 17 kg  
 acc. chair 34 kg

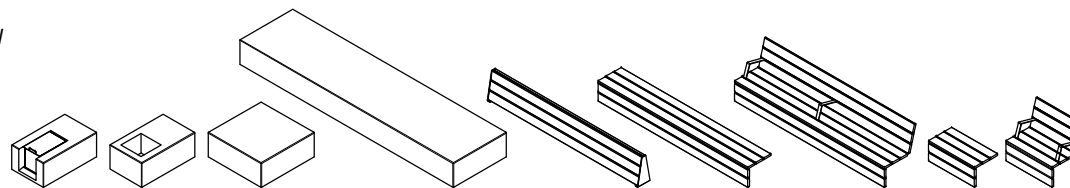

Update 02/02/2021  
 Cotas / Sizes cm

# GEOMETRÍA / GEOMETRY

E:1/30

ACCESORIO BANCO

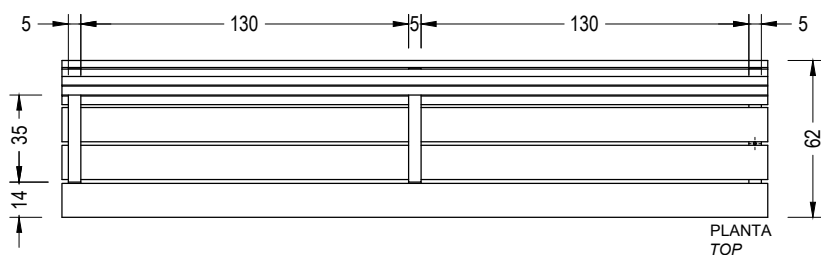
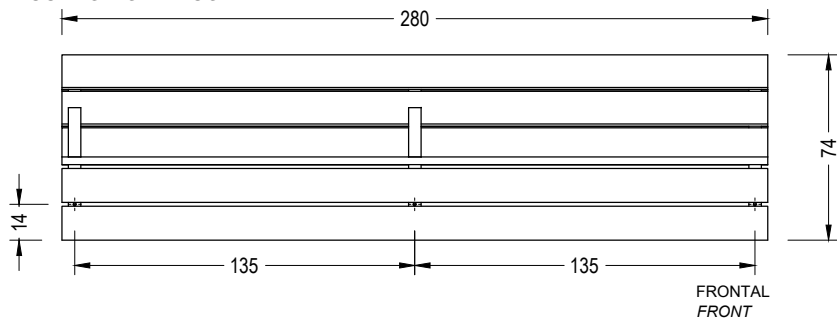

ACCESORIO BANCA

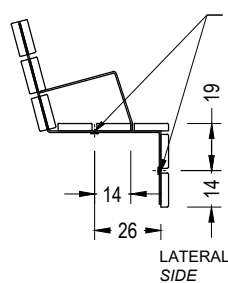
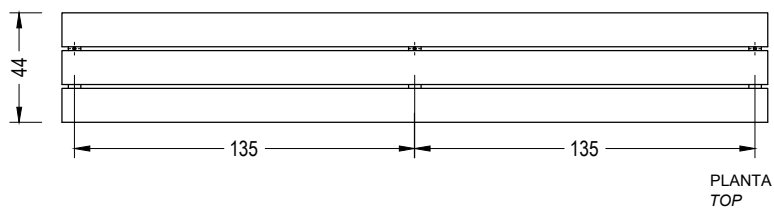
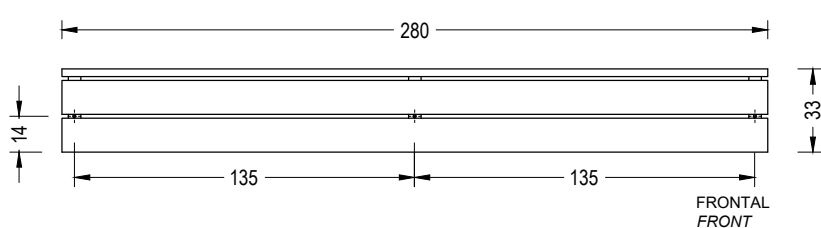

colisos / slotted holes  
 Ø9 x 20mm

ACCESORIO SILLA

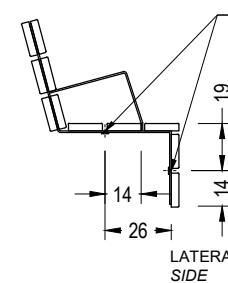
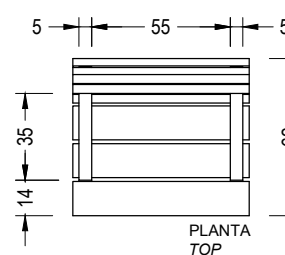
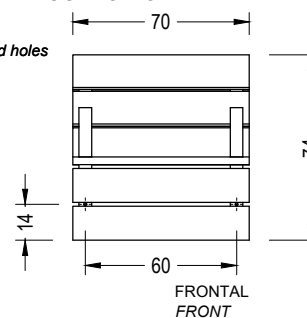

colisos / slotted holes  
 Ø9 x 20mm

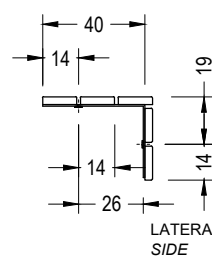

ACCESORIO ASIENTO

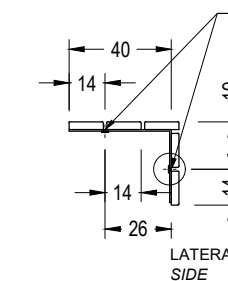
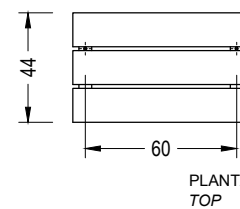
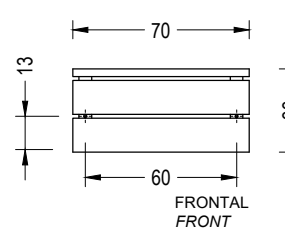

Incorpora arandelas de nylon para separar la madera del soporte / Includes nylon washers to separate the wood from the support

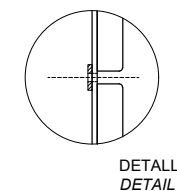

# CARACTERÍSTICAS / CHARACTERISTICS

MATERIAL hormigón  
 COLOR carta de colores estándar  
 ACABADO pulido e hidrofugado /  
 decapado e hidrofugado  
 CUBETAS acero inoxidable  
 COLOC. apoyado sin anclaje  
 PESO papelera 555 kg  
 cenicero 575 kg

MATERIAL concrete  
 COLOUR standard colour chart  
 FINISH polished and waterproofed /  
 etched and waterproofed  
 BUCKET stainless steel  
 FIXING free-standing  
 WEIGHT litter bin 555 kg  
 ashtray 575 kg

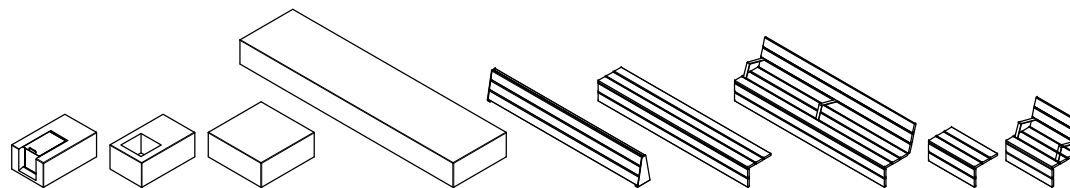

Update 12/02/2020  
 Cotas / Sizes cm

## INSTALACIÓN / INSTALLATION

elevación / hoisting  
 P = 555 kg / 575 kg  
 elevación con eslingas de poliéster /  
 hoisting with polyester slings

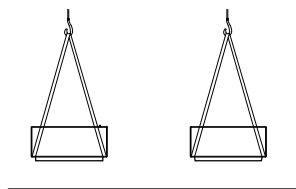

E:1/100

## GEOMETRÍA / GEOMETRY

E:1/30

### LONGO PAPELERA

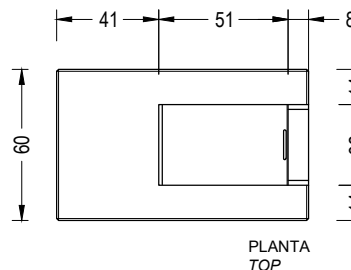
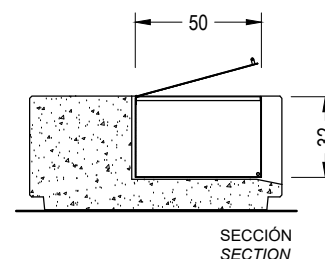
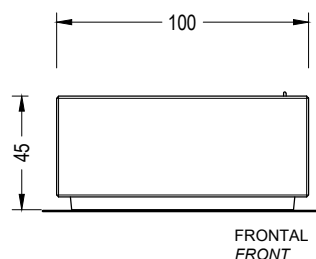
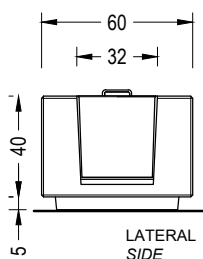

### LONGO CENICERO

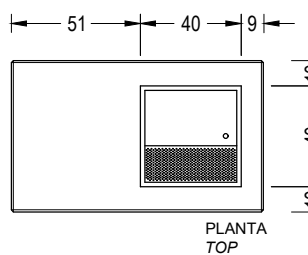
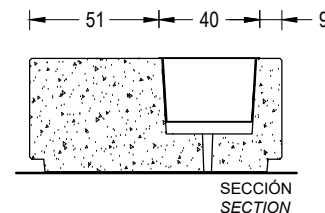
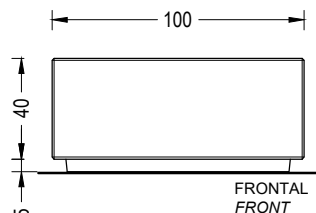
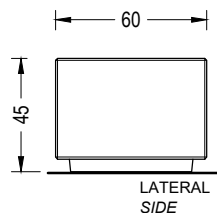

SOCRATES + ACC. LONGO

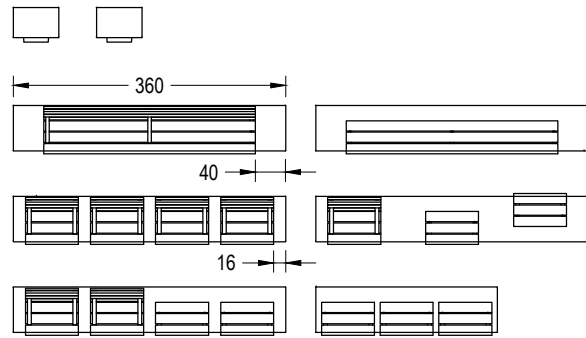

BOX + ACC. LONGO

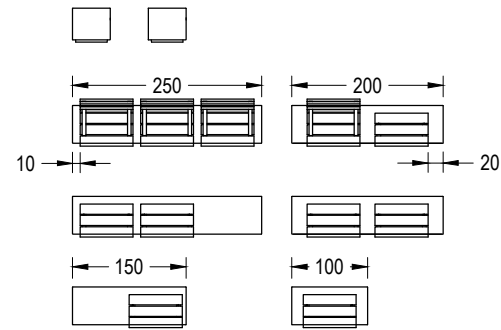

GARONNE + ACC. LONGO

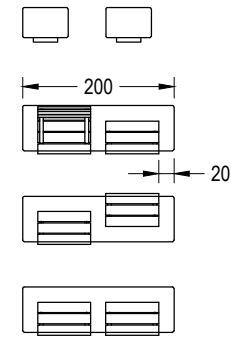

BARANA + ACC. LONGO

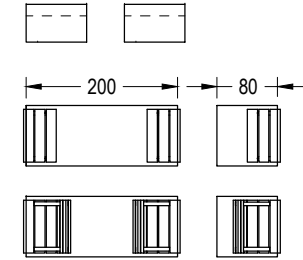

GODOT + ACC. LONGO

