

CARACTERÍSTICAS / CHARACTERISTICS

MATERIAL hormigón
COLOR carta de colores estándar
ACABADO decapado e hidrofugado
ACCES. acero zincado
ACABADO pintado plata texturizado
COLOC. anclado con tornillos
PESO central: 815 kg
 izq/dch: 830 kg
 individual: 865 kg

MATERIAL concrete
COLOUR standard colour chart
FINISH etched and waterproofed
ACCES. zinc plated steel
FINISH textured silver coated
FIXING anchored with screws
WEIGHT central: 815 kg
 left/right: 830 kg
 individual: 865 kg

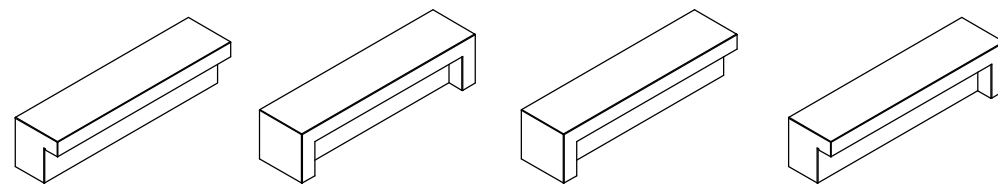

Update 09/03/2021
 Cotas / Sizes cm

INSTALACIÓN / INSTALLATION

GEOMETRÍA / GEOMETRY

elevación / hoisting
 P = 815 kg / 830 kg / 865 kg

elevación con eslingas de poliéster / hoisting with polyester slings

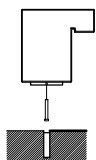
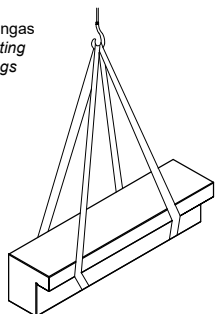

rosar tornillos a fondo (Ø16 x 140 mm)
 tightly screw stud bolts (Ø16 x 140 mm)

taladrar el pavimento (Ø40x180) y rellenar de resina o mortero rico
 drill the pavement (Ø40x180) and fill with resin or fat mortar

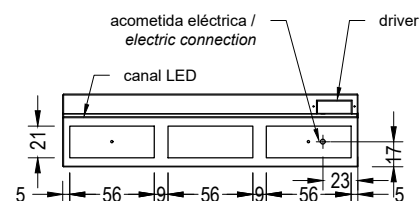
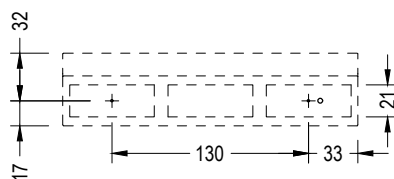

E:1/50

COMÚ recto central

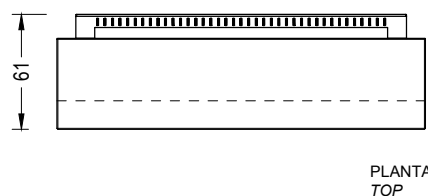
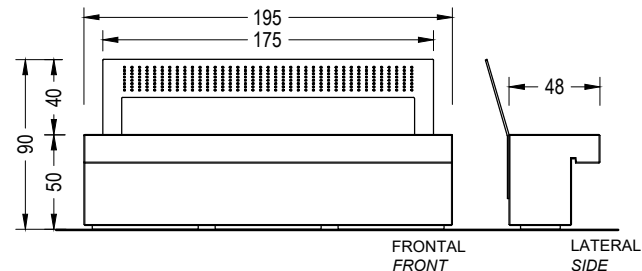

*Respaldo y apoyabrazos opcional para todos los modelos /
 Backrest and armrest optional for all models

COMÚ recto derecho

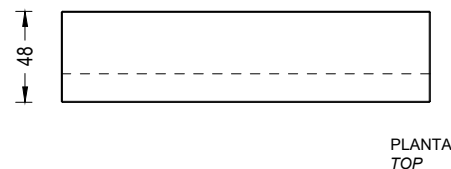
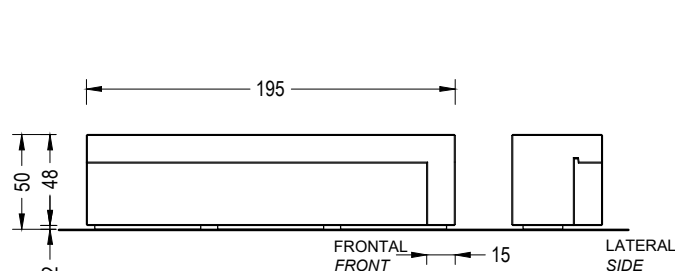

COMÚ recto individual

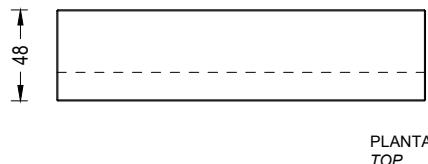
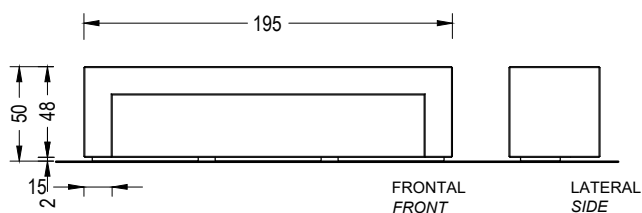

COMÚ recto izquierdo

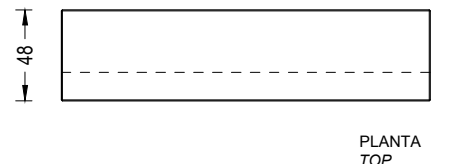
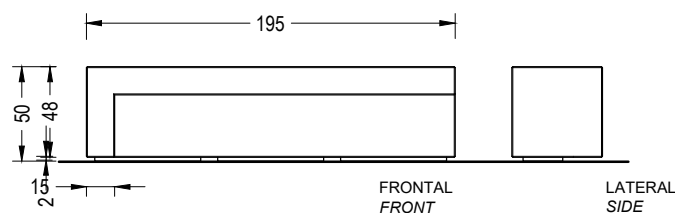

E:1/40

CARACTERÍSTICAS / CHARACTERISTICS

MATERIAL hormigón
COLOR carta de colores estándar
ACABADO decapado e hidrofugado
ACCES. acero zincado
ACABADO pintado plata texturizado
COLOC. anclado con tornillos
PESO central: 815 kg
 izq/dch: 830 kg
 individual: 865 kg

MATERIAL concrete
COLOUR standard colour chart
FINISH etched and waterproofed
ACCES. zinc plated steel
FINISH textured silver coated
FIXING anchored with screws
WEIGHT central: 815 kg
 left/right: 830 kg
 individual: 865 kg

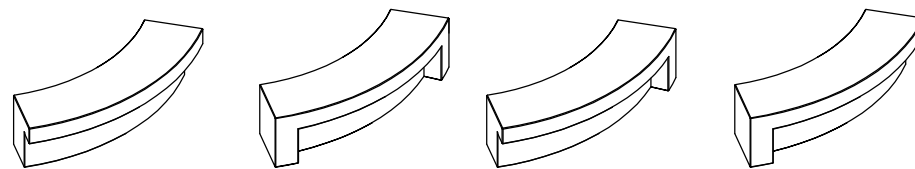

Update 09/03/2021
 Cotas / Sizes cm

INSTALACIÓN / INSTALLATION

GEOMETRÍA / GEOMETRY

elevación / hoisting
 P = 815 kg / 830 kg / 865 kg

elevación con eslingas de poliéster / hoisting with polyester slings

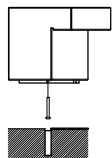
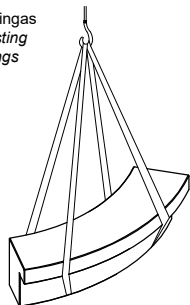

rosacar tornillos a fondo (Ø16 x 140 mm)
 tightly screw stud bolts (Ø16 x 140 mm)

taladrar el pavimento (Ø40x180) y rellenar de resina o mortero rico
 drill the pavement (Ø40x180) and fill with resin or fat mortar

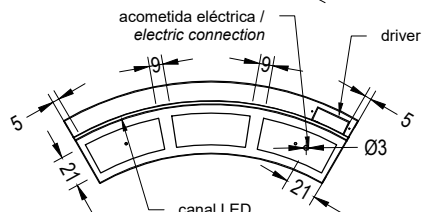
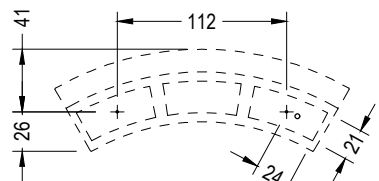

E:1/50

COMÚ convexo central

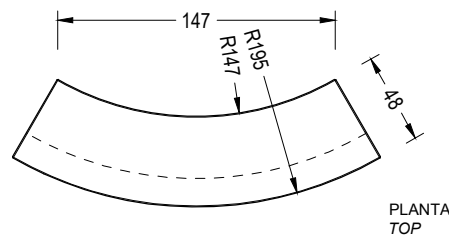
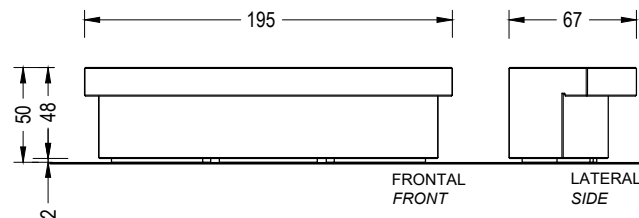

* Apoyabrazos opcional para todos los modelos /
 Optional armrest for all models

COMÚ convexo derecho

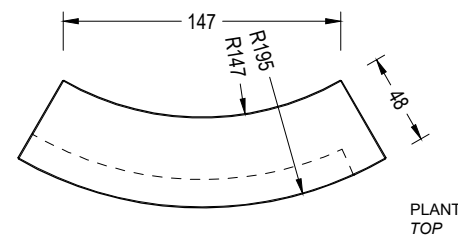
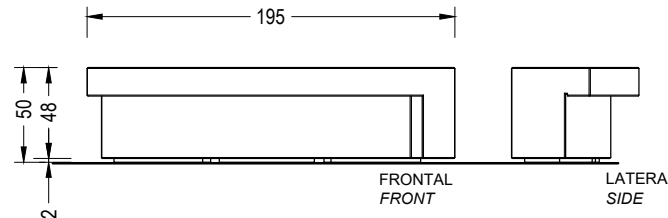

E:1/40

COMÚ convexo individual

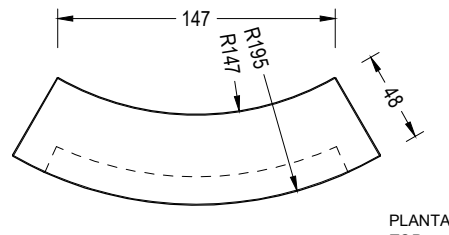
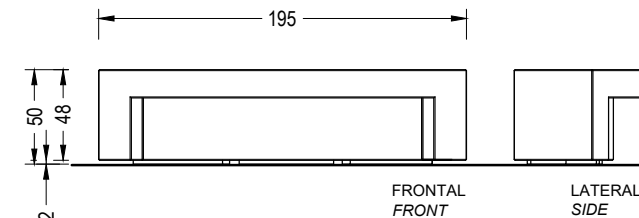

COMÚ convexo izquierdo

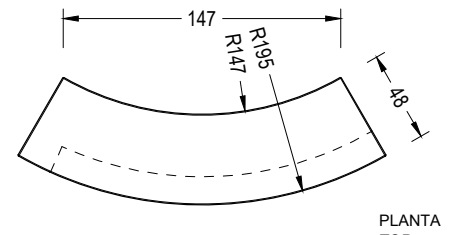
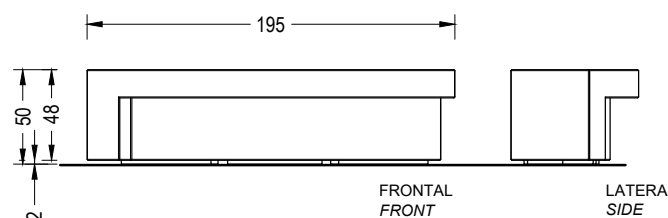

CARACTERÍSTICAS / CHARACTERISTICS

MATERIAL hormigón
COLOR carta de colores estándar
ACABADO decapado e hidrofugado
ACCES. acero zincado
ACABADO pintado plata texturizado
COLOC. anclado con tornillos
PESO central: 815 kg
 izq/dch: 830 kg
 individual: 865 kg

MATERIAL concrete
COLOUR standard colour chart
FINISH etched and waterproofed
ACCES. zinc plated steel
FINISH textured silver coated
FIXING anchored with screws
WEIGHT central: 815 kg
 left/right: 830 kg
 individual: 865 kg

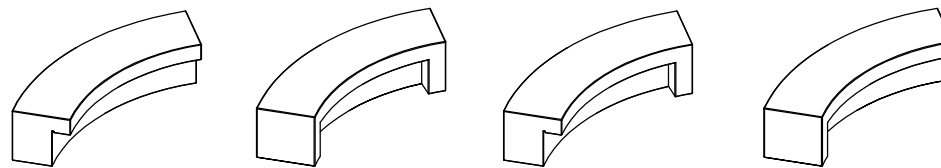

Update 11/03/2021
 Cotas / Sizes cm

INSTALACIÓN / INSTALLATION

GEOMETRÍA / GEOMETRY

elevación / hoisting
 P = 815 kg / 830 kg / 865 kg

elevación con eslingas
 de poliéster / hoisting
 with polyester slings

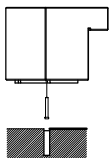
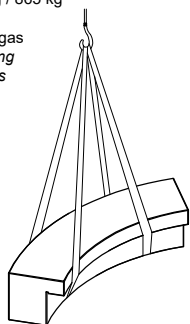

rosar tornillos a fondo (Ø16 x 140 mm)
 tightly screw stud bolts (Ø16 x 140 mm)

taladrar el pavimento (Ø40x180) y rellenar de resina o mortero rico
 drill the pavement (Ø40x180) and fill with resin or fat mortar

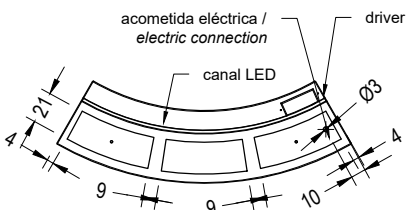
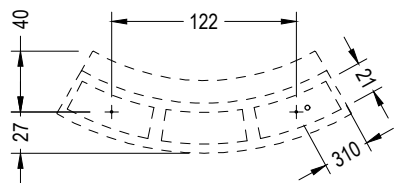

E:1/50

COMÚ cóncavo central

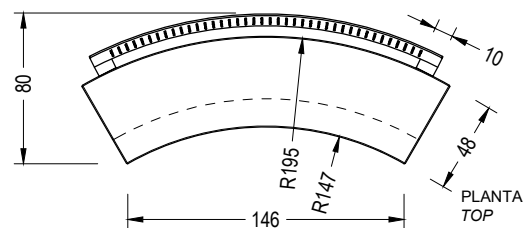
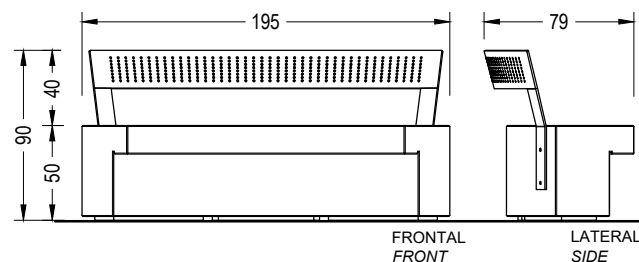

*Respaldo y apoyabrazos
 opcional para todos los modelos /
 Backrest and armrest optional for
 all models

COMÚ cóncavo individual

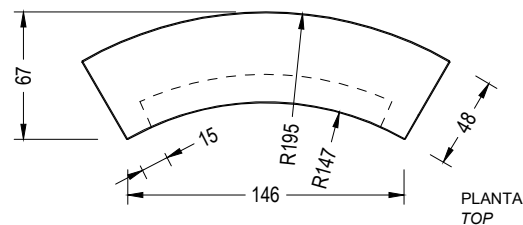
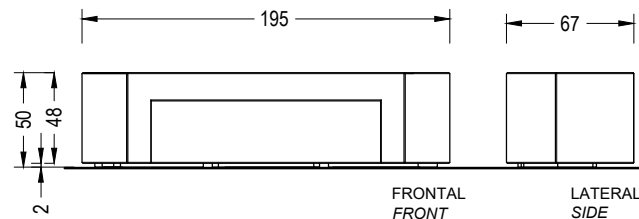

COMÚ cóncavo derecho

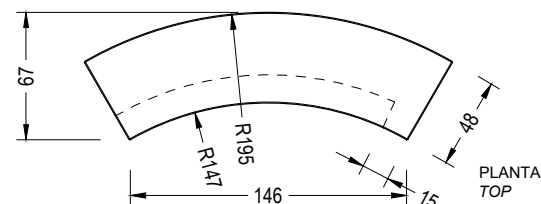
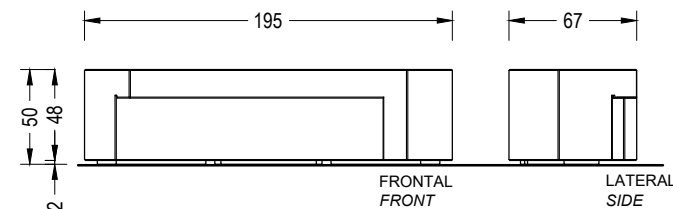

COMÚ cóncavo izquierdo

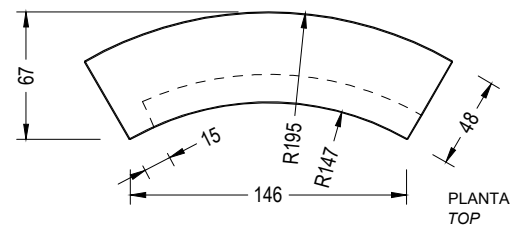
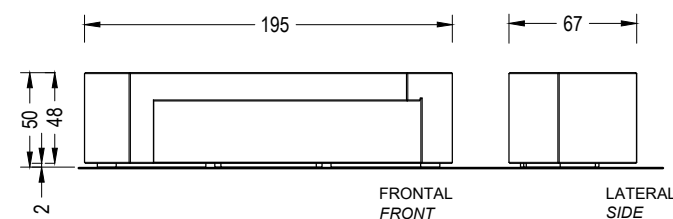

E:1/40

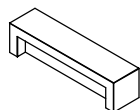

COMU RECTO INDIVIDUAL

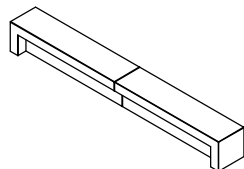

COMU RECTO DUPLO

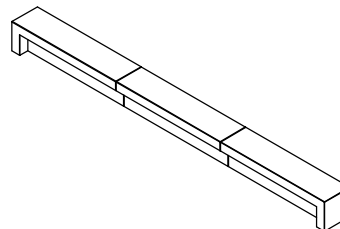

COMU RECTO LINE

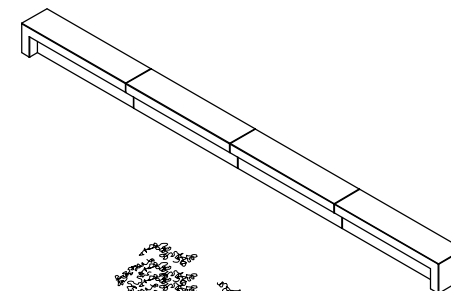

COMU RECTO LINE
+ 1 COMU EXTENSION (RECTO CENTRAL)

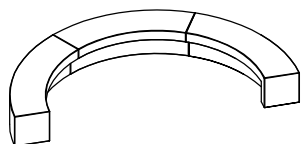

1 COMÚ CÓNCAVO CENTRAL +
1 COMÚ CÓNCAVO DERECHO +
1 COMÚ CÓNCAVO IZQUIERDO

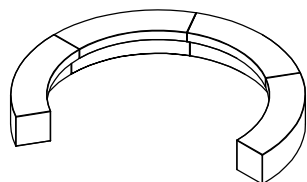

2 COMÚ CÓNCAVO CENTRAL +
1 COMÚ CÓNCAVO DERECHO +
1 COMÚ CÓNCAVO IZQUIERDO

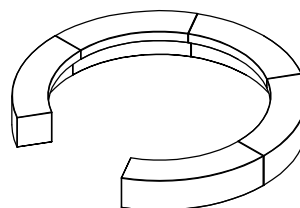

3 COMÚ CÓNCAVO CENTRAL +
1 COMÚ CÓNCAVO DERECHO +
1 COMÚ CÓNCAVO IZQUIERDO

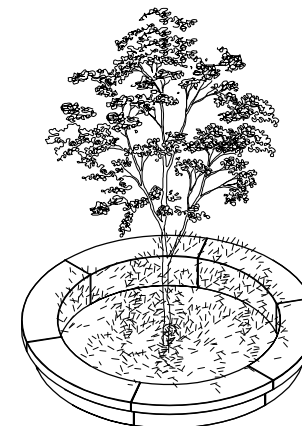

6 COMÚ CONVEXO CENTRAL

E:1/200

E:1/20

OTROS EJEMPLOS DE AGREGACIONES / OTHER EXAMPLES OF AGGREGATIONS

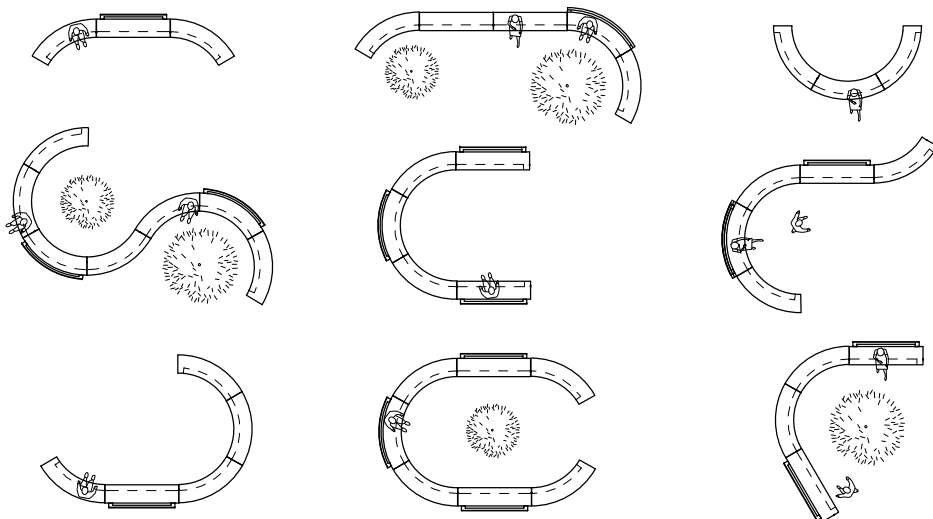

ESPECIFICACIONES ILUMINACIÓN / LIGHTING SPECIFICATIONS

LED	
Tensión de trabajo <i>Operating voltage</i>	24V
Potencia <i>Power</i>	8W/m
Temperatura de color <i>Color temperature</i>	6000K
Grado de protección <i>Degree of protection</i>	IP67

Driver Vossloh o similar <i>Driver Vossloh or similar</i>	
Potencia <i>Power</i>	30W
Voltaje <i>Voltage</i>	220-240V
Frecuencia <i>Frequency</i>	50-60Hz
Factor de potencia <i>Power factor</i>	>0,9
Grado de protección <i>Degree of protection</i>	IP67

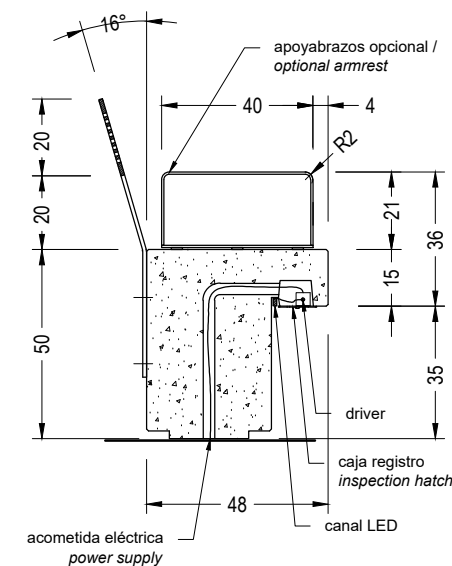

COMÚ convexo central

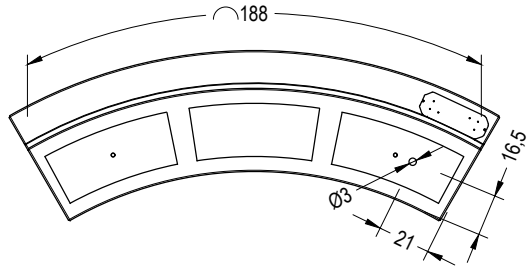

COMÚ cóncavo central

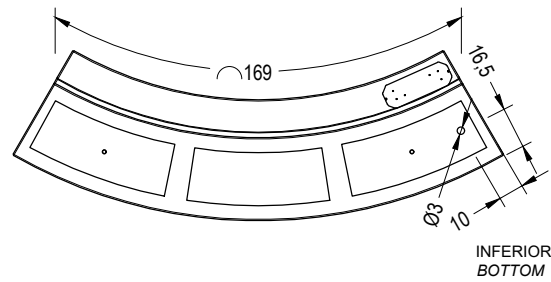

COMÚ recto central

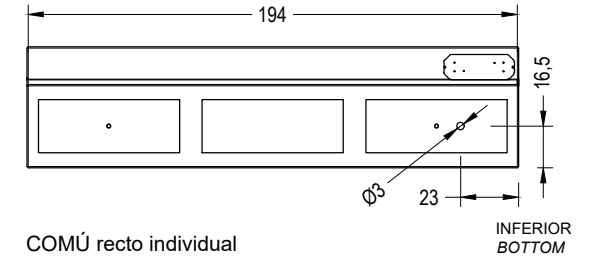

COMÚ convexo individual

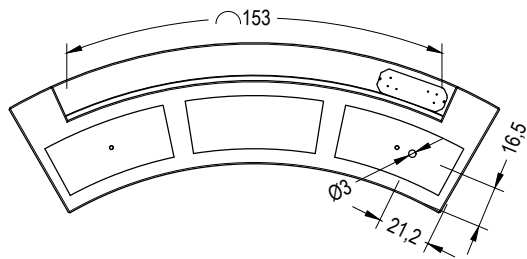

COMÚ cóncavo individual

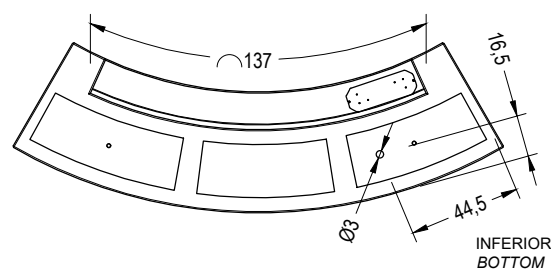

COMÚ recto individual

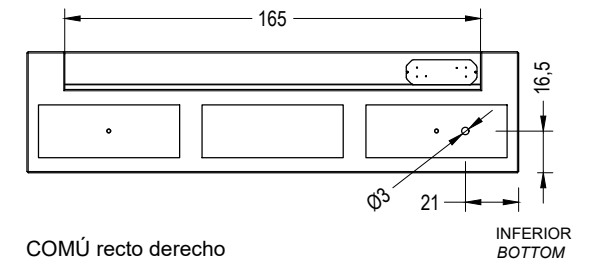

COMÚ convexo derecho

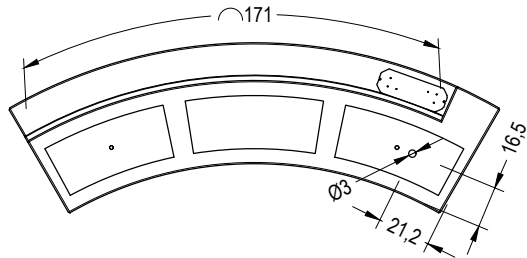

COMÚ cóncavo derecho

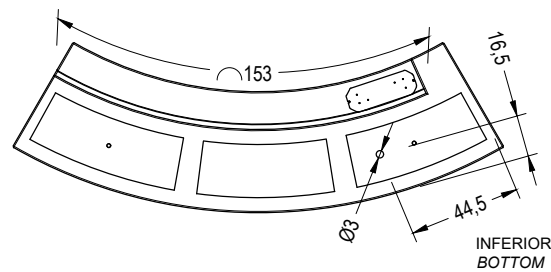

COMÚ recto derecho

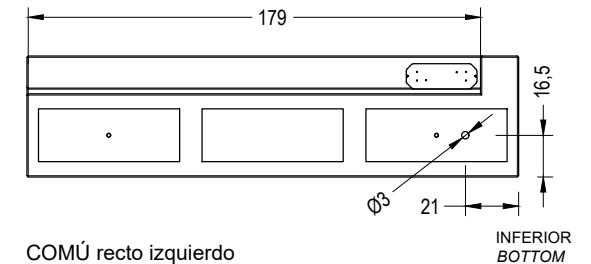

COMÚ convexo izquierdo

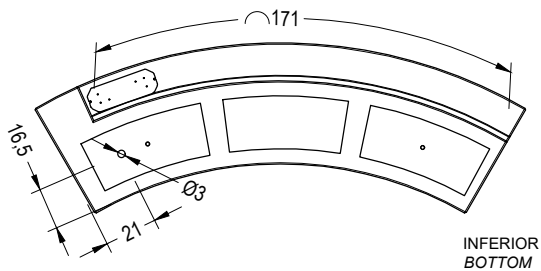

COMÚ cóncavo izquierdo

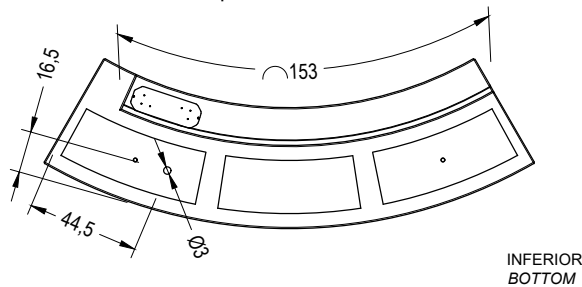

COMÚ recto izquierdo

